

SERIES

BP

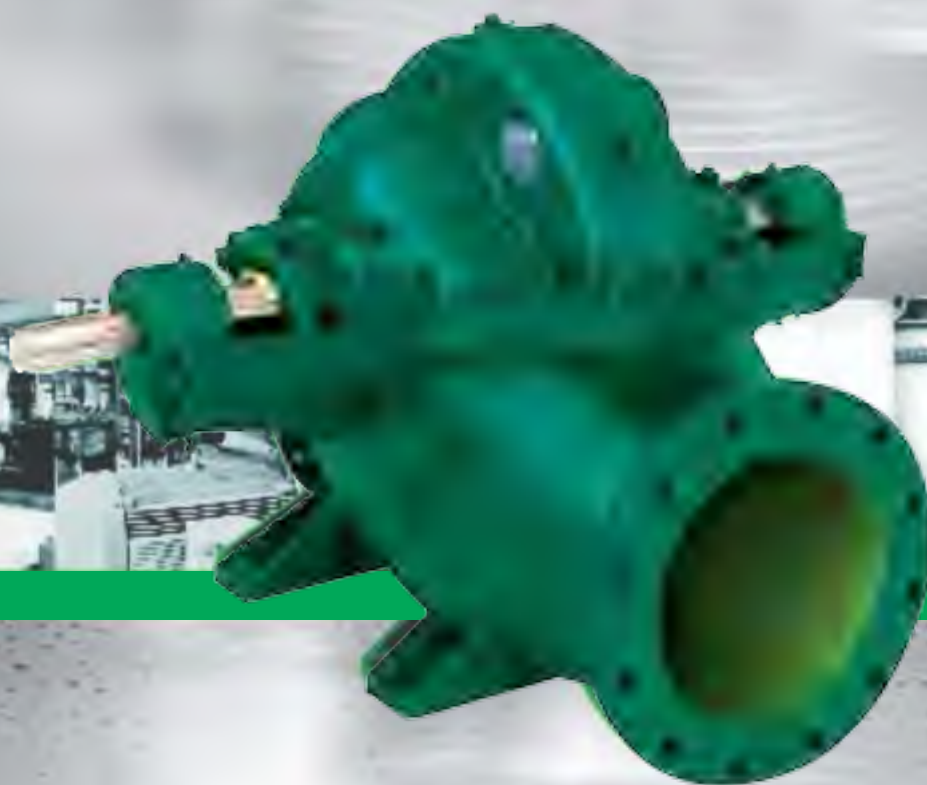

 **IMBIL**[®]
Pumping Solutions

INTRODUCTION

This catalog describes the pump models of the BP line manufactured by IMBIL and includes technical information on construction techniques and characteristic curves of each model. IMBIL and its representatives are always at your service to provide you with any further information and technical assistance.

NOTES

We reserve the right to make any modifications that we deem necessary or required to our products at any time without entailing any obligations of any nature.

The illustrations in the catalog are indicative only, should any doubts related to interpretation arise, please consult an authorized representative.

APPLICATION

BP Pump Series is recommended for Water supply, Large irrigation areas, Draining, Fire fighting, Liquid cooling in Chemical, Petrochemical, Pulp and Paper and Textile industries, among others.

CONSTRUCTION TECHNIQUES

VOLUTE

Horizontally split along the shaft providing easy access to the impeller for inspection and maintenance without the need of replacing the suction and discharge pipings. The feet and the suction and discharge flanges are integrally cast into the casing.

IMPELLERS AND WEAR RINGS

All pumps use closed impellers keyed on the shafts. The axial fixation of the impellers is made through protective sleeves and check nuts, positioned by means of locking bolts.

The pumps have replaceable wear rings in the volute case. The type and the fixation system of the wear rings vary according to the particular requirements of each pump. The larger sized pumps usually employ L-shaped wear rings and the smaller pumps usually use cylindrical wear rings.

Some BP pumps are originally equipped with replaceable wear rings, either cylindrical or flanged, which are pressed into the impellers.

SHAFTS AND SLEEVES

The shafts were designed and machined so as to secure the impellers in place and their stiffness ensures long life to the bearings and packings. In order to protect the shafts from wear, they have been fitted with protective sleeves fastened by means of check nuts.

PACKING

The stuffing boxes are very deep in order to prevent air suction. The gasket rings of graphitized asbestos of square section are normally used in all pumps, except when meeting special service conditions. The stuffing box packing glands are screwed with nuts through tap bolts fastened to the volute cases.

As a whole, the gasket boxes have a back ring and a lantern ring. When sealing liquid is used, it is usually collected in the discharge volute of the pump itself. If the pumped liquid is incompatible with the sealing function, an external source is used.

Note: On customer demand, the sealing can be made through Mechanical Seal.

BEARINGS

All pumps are supplied with heavy-duty bearings and can have a ball bearing on each side or a roller bearing on the operation side and a ball bearing on the free side, depending on the requirements of each pump. Whichever the case, the external rings of the bearings are tightened between a bearing internal step and a plug on the cover so as to prevent any axial displacements. In the pumps whose bearing brackets are integrated into the volute case, the bearings are positioned through conical pins. The lubrication of the bearings is grease- or oil-based.

APPLICATION CHART

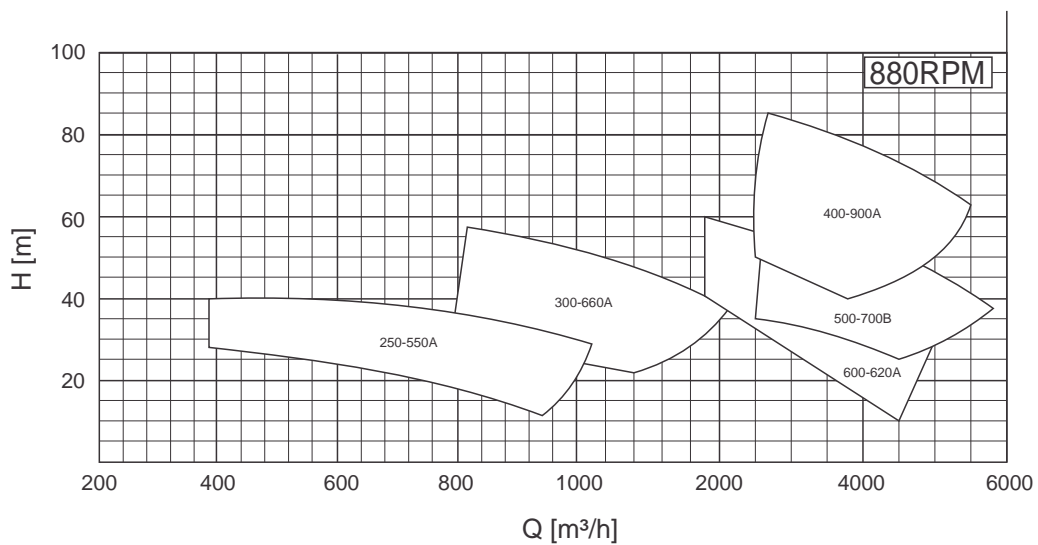
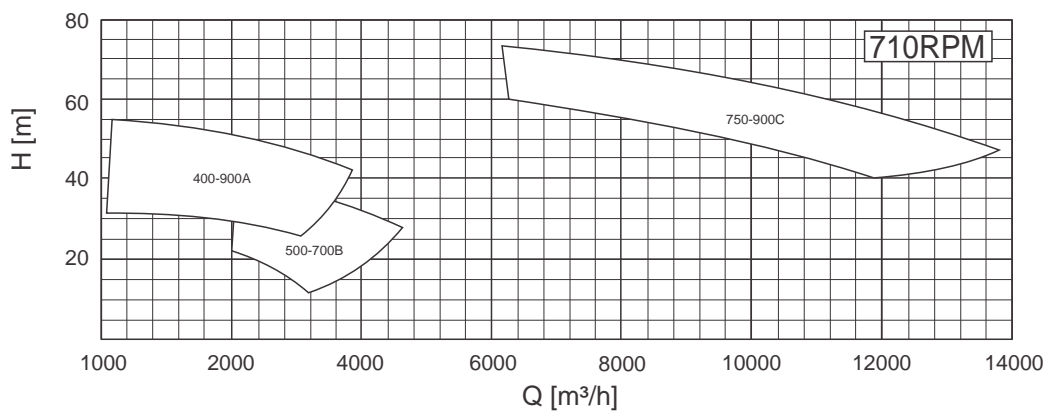
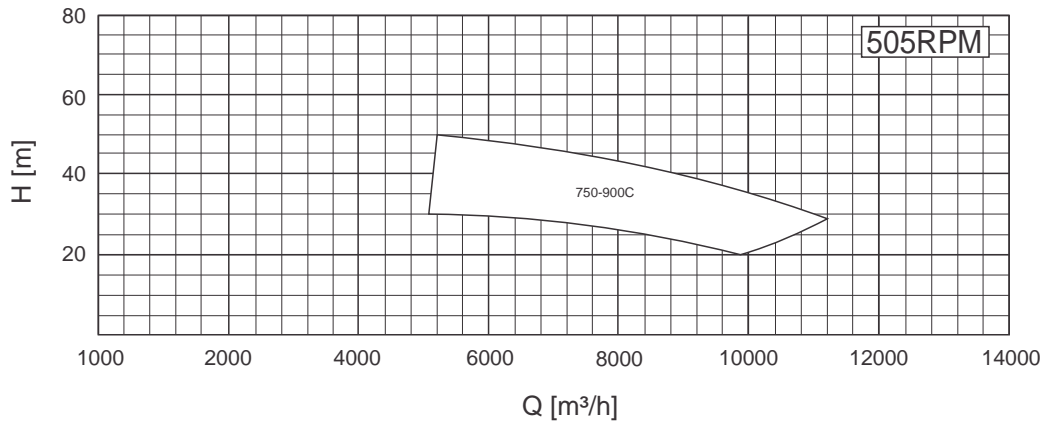

APPLICATION CHART

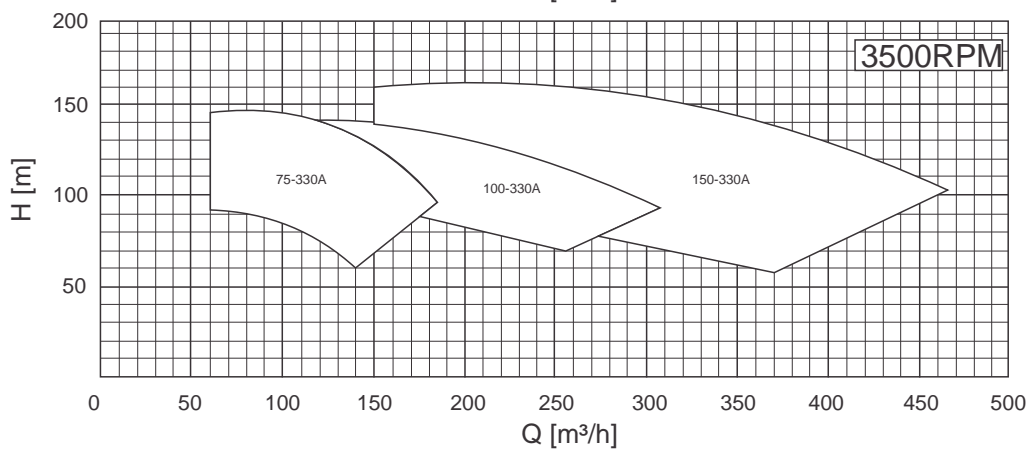
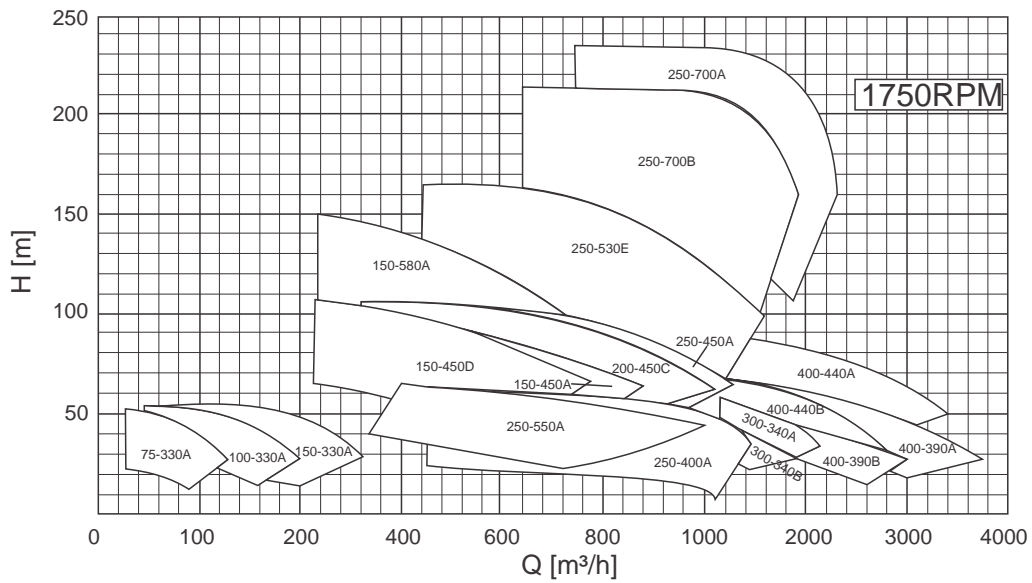
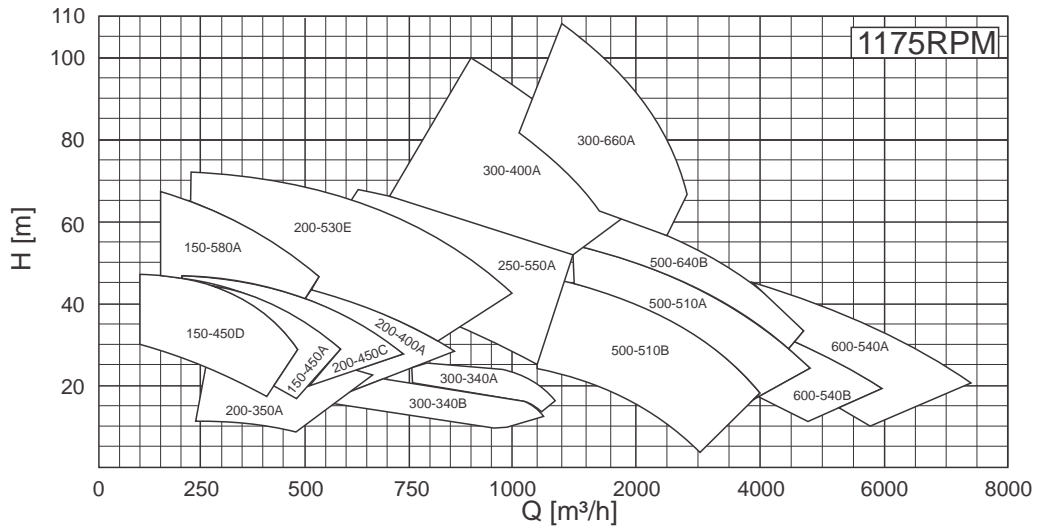

TECHNICAL DATA

Hydrostatic Test Pressure:

As per Hydraulic Institute

Maximum Temperature:

105°C

Motor Driver

The driver is performed by means of elastic coupling, by Electric Motor, Combustion Engine, Turbine, etc.

Accessories

The following accessories are optionally available:

- IMBIL standard coupling or coupling meeting other manufacturers' requirements.
- IMBIL standard coupling protector.
- IMBIL standard base.

Peripheral Speed (m/s)

When determining the pump operation rotation, in addition to the maximum discharge pressure, the impeller maximum peripheral speed must also be considered as regards its construction material.

ASTM A48 CL30	40m/s
ASTM A536 65.45.12	60m/s
SAE 40	60m/s
CF 8M	80m/s

Power Reserve

Power Required by Pump	Electric motor driver power reserve
Up to 30 HP	approx. 30%
Up to 75 HP	approx. 15%
Over 75 HP	approx. 10%

For oil-based lubrication, we recommend:

Up to 3000 rpm: Castrol Hyspin AWS 68,
Over 3000 rpm Castrol Hyspin AWS 46 or similar

For grease-based lubrication, we recommend:

Castrol LM 2 or similar

Rotation Direction

Since the pump may be coupled from any extremities, the rotation direction may be clockwise or anti-clockwise. The shaft may be inverted without requiring any special adaptation.



Clockwise rotation

Anti-clockwise rotation



TECHNICAL DATA

Data		Models															
Unit		75-330 A	100-330 A	150-330 A	150-450 A	150-450 D	150-580 A	200-350 A	200-450 A	200-340 C	200-530 E	250-400 A	250-550 A	250-700 A	250-700 B	300-340 A	300-340 B
Inlet/outlet opening	mm	30	37	35	33	34	34	70	52	47	49	81	89	65	41	80	64
Double Volute				X	X	X	X				X						
Maximum Rotation	rpm	3500	3500	3500	1750	1750	1750	1775	1750	1775	1775	1750	1750	1750	1750	1750	1750
ICP with water	kg/m ³	100	100	100	100	100	100	100	100	100	100	100	100	100	100	100	100
Weight	kg	190	265	343	555	585	645	550	701	701	561	545	500	1317	1317	765	765
Minimum Flow	m ³ /h	-	270	103	265	315	300	300	442	300	580	600	600	300	300	300	265
Maximum Flow	m ³ /h	65	83	164	400	300	450	450	883	454	815	1030	900	1000	950	720	624
Maximum Flow	m ³ /h	67	138	254	-	-	-	-	-	-	-	-	-	-	-	-	-
Flanges		See Characteristic Curve															
Bearing		3030 R16 1.125 lb FF or 2032 R FF															
Bearing (optional C3) Coupling Side		6407	6211	6211	6211	6213	6213	6310	6212	6212	6312	6359	6313	7217R/2X	7217R/2X	5014	5014
Castnet	psi	710"	10"	10"	10"	10"	10"	50"	50"	50"	50"	10"	10"	50"	50"	50"	50"

Dados		Models															
Unit		300-400 A	300-660 A	400-390 A	400-390 B	400-440 A	400-440 B	400-900 A	500-510 A	500-510 B	500-640 A	500-640 B	500-700 B	600-620 A	600-540 A	600-540 B	750-1000 C
Inlet/outlet opening	mm	67	80	112	110	93	115	160	140	109	105	108	173	186	113	143	143
Double Volute				X	X	X	X										
Maximum Rotation	rpm	1750	1775	1750	1750	1750	1750	1800	1800	1800	1800	1800	1800	1800	1800	1800	1800
ICP with water	kg/m ³	100	100	100	100	100	100	100	100	100	100	100	100	100	100	100	100
Weight	kg	300	2000	1078	1078	1274	1274	3400	1520	1528	2001	2301	2400	5900	2725	2725	7900
Minimum Flow	m ³ /h	-	-	-	-	-	-	-	-	-	-	-	2400	2005	-	-	6000
Maximum Flow	m ³ /h	900	-	112	904	-	-	2500	1548	1100	1800	1440	-	-	2320	1800	-
Maximum Flow	m ³ /h	-	-	-	-	-	-	-	-	-	-	-	-	-	-	-	-
Flanges		See Characteristic Curve															
Bearing		DIN 2502 R4 10															
Bearing (optional C3) Coupling Side		6314 U	6319	6314 U	6314 U	6316 U	6316 U	6324	6316 U	6316	6320	6320	6319	6322	6322	6320	2228C
Castnet	mm	300"	300"	10"	10"	10"	10"	50"	50"	50"	50"	50"	50"	10"	10"	50"	34"

MAIN DIMENSIONS

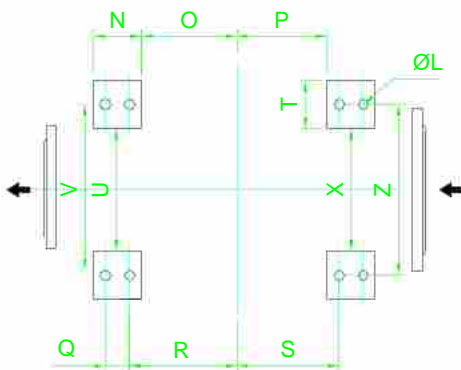
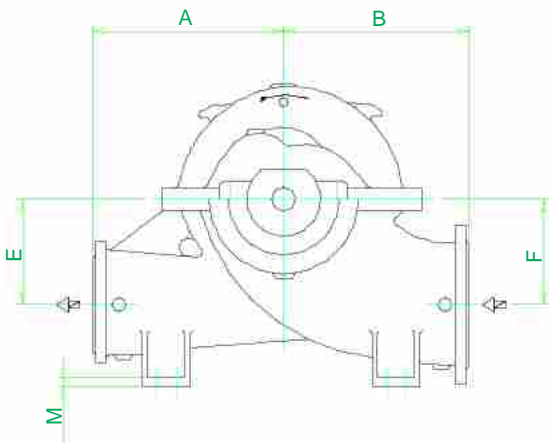
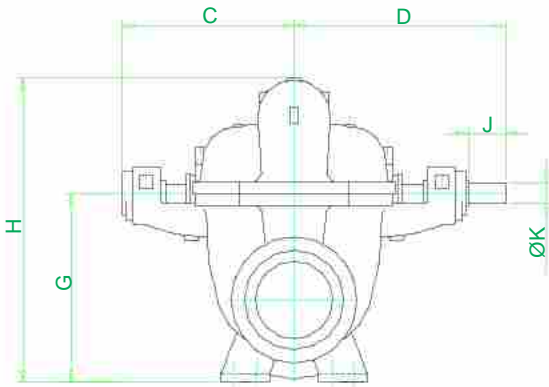

Model	Flange		Dimension									
	Suction	Discharge	A	B	C	D	E	F	G	H	J	ØK
75-330	100	75	279	293	326	429	191	153	253	483	106	34,8
100-330	150	100	308	333	400	530	195	165	280	490	91	43
150-330	200	150	358	380	400	530	235	211	338	568	91	43
150-450	250	150	419	457	505	621	254	254	408	718	143	54,8
150-580	250	150	508	530	505	665	356	356	508	883	156	63,5
200-350	305	203	400	483	481	616	254	254	425	711	184	49,5
200-450	300	200	419	559	532	663	279	279	457	768	128	54,8
200-530	350	200	508	559	568	740	305	305	521	883	175	73
250-400	300	250	356	457	448	553	267	267	533	853	115	55
250-550	355	254	495	635	580	743	355	355	572	912	169	63,5
250-700	350	250	495	675	560	764	445	445	650	1153	205	80
300-340	350	300	500	650	586	741	330	330	640	1040	155	70
300-400	350	300	650	550	575	720	325	325	600	985	145	70
300-660	457	305	635	838	733	967	419	419	673	1162	216	93,6
400-390	500	400	460	680	680	860	370	370	730	1180	160	65
400-440	500	400	650	700	685	905	390	390	750	1210	180	75
400-900	609	406	813	965	768	994	558	558	927	1578	203	115,8
500-510	600	500	550	850	820	905	475	475	900	1460	180	75
500-640	600	500	800	850	890	1117	495	495	920	1520	206	95
500-700	609	508	813	940	784	1016	546	546	902	1483	237	92
600-540	700	600	900	1100	885	1080	610	610	1100	1850	180	75
600-620	1060	867	916	1076	841	1023	583	544	1135	1766	193,5	105
750-1000	914	762	1219	1321	1016	1219	813	813	1321	2146	283	139,7

Model	Dimension												
	ØL	M	N	O	P	Q	R	S	T	U	V	X	Z
75-330	22	24	110	65	65	-	118	118	-	-	178	-	178
100-330	22	24	110	80	80	-	127	127	104	144	305	144	305
150-330	22	24	125	90	90	-	153	153	-	-	356	-	356
150-450	28,6	32	114	172	172	-	229	229	114	356	458	356	458
150-580	28,6	38	127	190	190	-	254	254	127	330	458	330	458
200-350	28,6	28,6	114	172	172	-	229	229	114	356	458	356	458
200-450	28,6	32	114	172	172	-	229	229	114	432	534	432	561
200-530	32	51	127	190	190	-	254	254	127	483	610	483	610
250-400	22	25	124	105	105	-	170	172	-	-	342	-	342
250-550	32	32	127	211	241	-	229	229	143	457	584	457	584
250-700	32	30	130	240	240	-	305	305	65	520	584	520	584
300-340	33	30	180	170	270	-	260	360	150	240	440	380	580
300-400	26	30	200	250	170	-	356	270	160	420	620	240	440
300-660	35	44	152	280	280	-	356	356	152	712	864	712	864
400-390	33	30	180	140	240	-	230	330	150	300	500	600	800
400-440	33	30	180	300	300	-	390	390	150	300	500	600	800
400-900	41	51	203	406,5	406,5	-	508	508	203	813	1016	813	1016
500-510	33	35	300	100	250	150	175	325	200	400	640	700	940
500-640	33	35	300	300	300	150	375	375	200	400	640	700	94
500-700	35	51	203	279,5	279,5	-	457	457	203	712	457	712	457
600-540	33	35	300	400	500	150	475	575	220	360	550	660	85
600-620	30	50	250	429	421	-	553	546	250	955	600	900	1255
750-1000	48	57	356	47	472	-	650	650	178	1117	660	1117	660

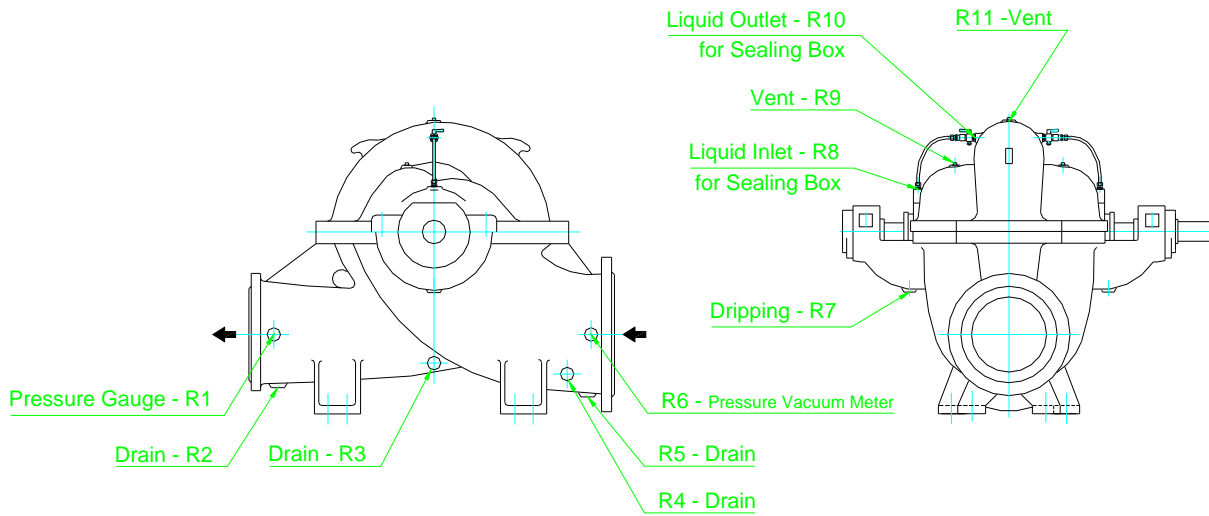

Model	Roscas BSP										
	R1	R2	R3	R4	R5	R6	R7	R8	R9	R10	R11
75-330	1/4"	1/2"	N.A.	N.A.	1/2"	1/4"	1/2"	1/8"	1/2"	1/8"	1/2"
100-330	1/4"	1/2"	N.A.	N.A.	1/2"	1/4"	1/2"	1/8"	1/2"	1/8"	1/2"
150-330	1/4"	1/2"	N.A.	N.A.	1/2"	1/4"	1/2"	1/8"	1/2"	1/8"	1/4"
150-450	1/4"	1/2"	N.A.	N.A.	1/2"	1/4"	1/2"	1/4"	3/4"	N.A.	3/4"
150-580	1/4"	1/2"	N.A.	N.A.	1/2"	1/4"	1/2"	1/4"	3/4"	N.A.	3/4"
200-350	1/4"	1/2"	N.A.	N.A.	1/2"	1/4"	1/2"	1/4"	3/4"	1/4"	1/4"
200-450	1/4"	1/2"	N.A.	N.A.	1/2"	1/4"	1/2"	1/4"	3/4"	N.A.	3/4"
200-530	1/4"	1/2"	N.A.	N.A.	1/2"	1/4"	3/4"	1/4"	3/4"	N.A.	1/4"
250-400	1/4"	N.A.	3/4"	3/4"	N.A.	1/4"	1/2"	1/4"	N.A.	1/4"	3/4"
250-550	1/4"	1/2"	N.A.	N.A.	1/2"	1/4"	1/2"	1/4"	3/4"	1/4"	1/2"
250-700	1/4"	3/4"	N.A.	N.A.	3/4"	1/4"	3/4"	1/2"	1.1/4"	N.A.	3/4"
300-340	1/2"	3/4"	N.A.	N.A.	3/4"	1/2"	3/4"	1/2"	3/4"	N.A.	3/4"
300-400	1/2"	3/4"	N.A.	N.A.	3/4"	1/2"	3/4"	1/2"	3/4"	1/2"	3/4"
300-360	1/4"	3/4"	N.A.	N.A.	3/4"	1/2"	3/4"	1/2"	1.1/4"	1/2"	3/4"
400-390	1/2"	3/4"	N.A.	N.A.	3/4"	1/2"	3/4"	1/2"	3/4"	N.A.	3/4"
400-440	1/2"	3/4"	N.A.	N.A.	3/4"	1/2"	3/4"	1/2"	3/4"	N.A.	3/4"
400-900	1/2"	1"	N.A.	N.A.	1"	1/4"	3/4"	1/2"	1"	1/2"	1/4"
500-510	1/2"	1"	N.A.	N.A.	1"	1/2"	1"	1/2"	1"	N.A.	1"
500-640	1/2"	1"	N.A.	N.A.	1"	1/2"	1"	1/2"	N.P	N.A.	1"
500-700	1/4"	1"	N.A.	N.A.	1"	1/4"	3/4"	1/2"	N.P	1/2"	1/4"
600-540	1/2"	1"	N.A.	N.A.	1"	1/2"	1"	1/2"	1"	N.A.	1"
600-620	N.A.	N.A.	N.A.	N.A.	N.A.	N.A.	1"	1/2"	1/2"	1/2"	1"
750-1000	1/4"	1.1/2"	N.A.	N.A.	1.1/2"	1/4"	1"	1/2"	N.P	1/2"	2"

N.P - Connection not Provided
 N.A - Not Applicable

FLANGE STANDARDS

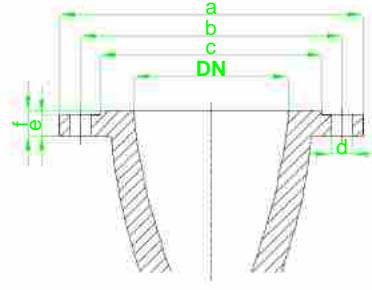
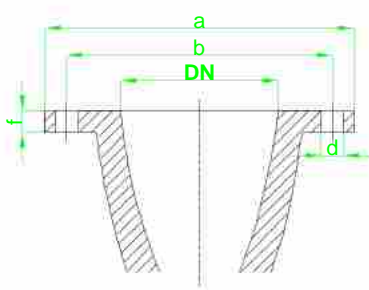

Standards: ANSI B16.1 FF						
Diam. Nom.	Clase	a	b	d	f	Qtde hole
75	125Lb	190	152	19	19	4
	250Lb	209	168	22	28	8
100	125Lb	228	190	19	24	8
	250Lb	254	200	22	32	8
125	125Lb	254	216	22	24	8
	250Lb	279	235	22	35	8
150	125Lb	279	241	22	25	8
	250Lb	317	270	22	36	12
200	125Lb	343	298	22	28	8
	250Lb	381	330	25	41	12
250	125Lb	406	362	25	30	12
	250Lb	444	387	28	48	16
300	125Lb	483	432	25	32	12
	250Lb	521	451	32	51	16
350	125Lb	533	476	28	35	12
	250Lb	584	514	32	54	20

Standards: ANSI B16.5 RF								
Diam. Nom.	Clase	a	b	c	d	e	f	Qtde hole
75	150Lb	190	152	127	19	1,6	24	4
	300Lb	209	168	127	22	1,6	28	8
100	150Lb	228	190	157	19	1,6	24	8
	300Lb	254	200	157	22	1,6	32	8
125	150Lb	254	216	185	22	1,6	24	8
	300Lb	279	235	185	22	1,6	35	8
150	150Lb	279	241	216	22	1,6	25	8
	300Lb	317	270	216	22	1,6	36	12
200	150Lb	343	298	270	22	1,6	28	8
	300Lb	381	330	270	25	1,6	41	12
250	150Lb	406	362	324	25	1,6	30	12
	300Lb	444	387	324	28	1,6	48	16
300	150Lb	482	432	381	25	1,6	32	12
	300Lb	521	451	381	32	1,6	51	16
350	150Lb	533	476	413	28	1,6	35	12
	300Lb	584	514	413	32	1,6	54	20

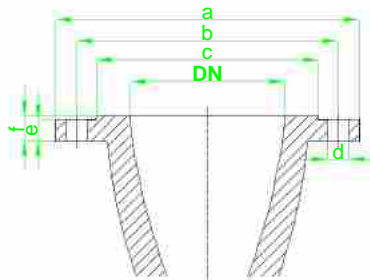

Standards: DIN 2532 - PN10							
Diam. Nom.	a	b	c	d	e	f	Qtde hole
300	445	400	370	23	4	28	12
350	505	460	429	23	4	30	16
400	565	515	480	28	4	32	16
450	615	565	530	28	4	32	20
500	670	620	582	28	4	34	20
600	780	725	682	31	5	36	20
700	895	840	794	31	5	40	24

Standards: DIN 2533 - PN16							
Diam. Nom.	a	b	c	d	e	f	Qtde hole
300	460	410	370	28	4	32	12
350	520	470	429	28	4	36	16
400	580	525	480	31	4	38	16
450	640	585	548	31	4	40	20
500	715	650	609	34	4	42	20
600	840	770	720	37	5	48	20
700	910	840	794	37	5	54	24

PART LIST

Code	Description
CA	Volute C case
TP	Pressure Cover
EX	Shaft
RO	Impeller
MN	Bearing
TM	Bearing Cover
TVE	Sealing Cover
AG	Stuffing box packing gland
ADCA	Volute case wear ring
ADRO (1)	Impeller wear ring (1)
BP	Shaft Sleeves
POAP	Check Nut
PEX	Shaft Nut
AC	Lantern ring
AF	Back ring
ANCE	Centrifuge ring
PI	Pin
ROL	Bearing
GAXE	Gasket (graphitized asbestos)
TORN	Tap

(1) Not used in all models

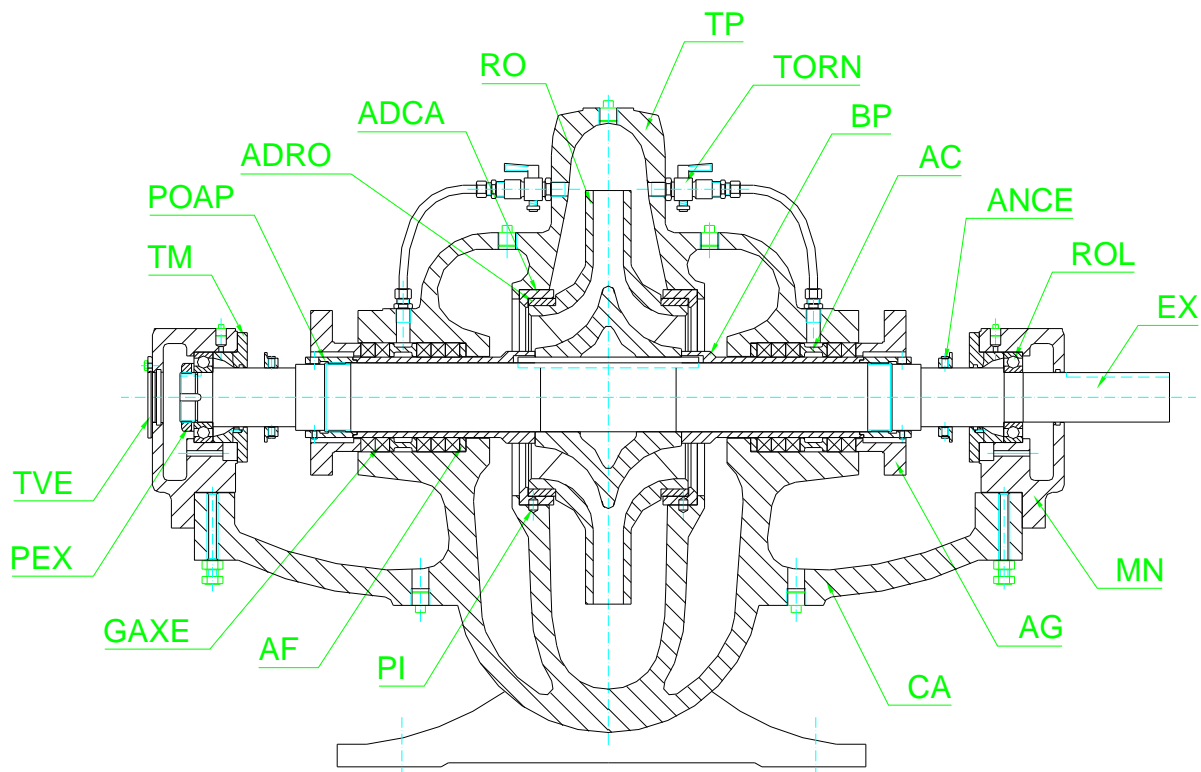

MATERIAL VERSIONS

Parts	Material Versions						
	V01	V02	V03	V04	V05	V06	V07
Volute Case	ASTM A48 CL30	ASTM A48 CL30	ASTM A48 CL30	ASTM A48 CL30	ASTM A48 CL30	ASTM A48 CL30	ASTM A536 65.45.12
Pressure cover	ASTM A48 CL30	ASTM A48 CL30	ASTM A48 CL30	ASTM A48 CL30	ASTM A48 CL30	ASTM A48 CL30	ASTM A536 65.45.12
Impeller	ASTM A48 CL30	ASTM A536 65.45.12	BRONZE CB31	BRONZE CB31	CF 8M	CA6NM	ASTM A536 65.45.12
Wear ring (volute case)	BRONZE CB31	BRONZE CB31	BRONZE CB31	BRONZE CB31	BRONZE CB31	BRONZE CB31	BRONZE CB31
Wear ring (impeller)	BRONZE CB31	BRONZE CB31	BRONZE CB31	BRONZE CB31	CF 8M	CF 8M	BRONZE CB31
Shaft	SAE1045	SAE1045	SAE1045	AISI316	SAE1045	SAE1045	SAE1045
Shaft sleeve	SAE1020	SAE1020	BRONZE TM23	BRONZE TM23	AISI316	AISI316	SAE1020
Bearing	ASTM A48 CL30	ASTM A48 CL30	ASTM A48 CL30	ASTM A48 CL30	ASTM A48 CL30	ASTM A48 CL30	ASTM A536 65.45.12

LIMITATIONS ON THE USE OF CAST IRON IMPELLERS:

1 -FIRE FIGHTING

If the function is limited to fire fighting, no restrictions apply.

Should the pump also have the function of collecting water, which is typical of ships and sea platforms, proceed according to item 3.

2 -TOWER CIRCULATION, COOLING AND BOILER FEED WATER

Cast Iron Impellers are not to be used. Preferably use impeller in CF 8M. Bronze impeller may be used as long as the NPSH available is the double of or larger/higher than the required NPSH.

3 -WATER OLLECTION

Cast iron rotor may be used only under the following conditions:

- NPSH available is more than two times the required NPSH.
- Installed power is lower than 500 HP.
- Volumetric flow is lower than 3000 m³/h.

4 -HIDROCARBONS, OILS, ETC.

Cast iron impellers may be used as long as the NPSH available is at least 50% higher than the required NPSH.

BP 75-330 ROTOR "A" 3500 RPM

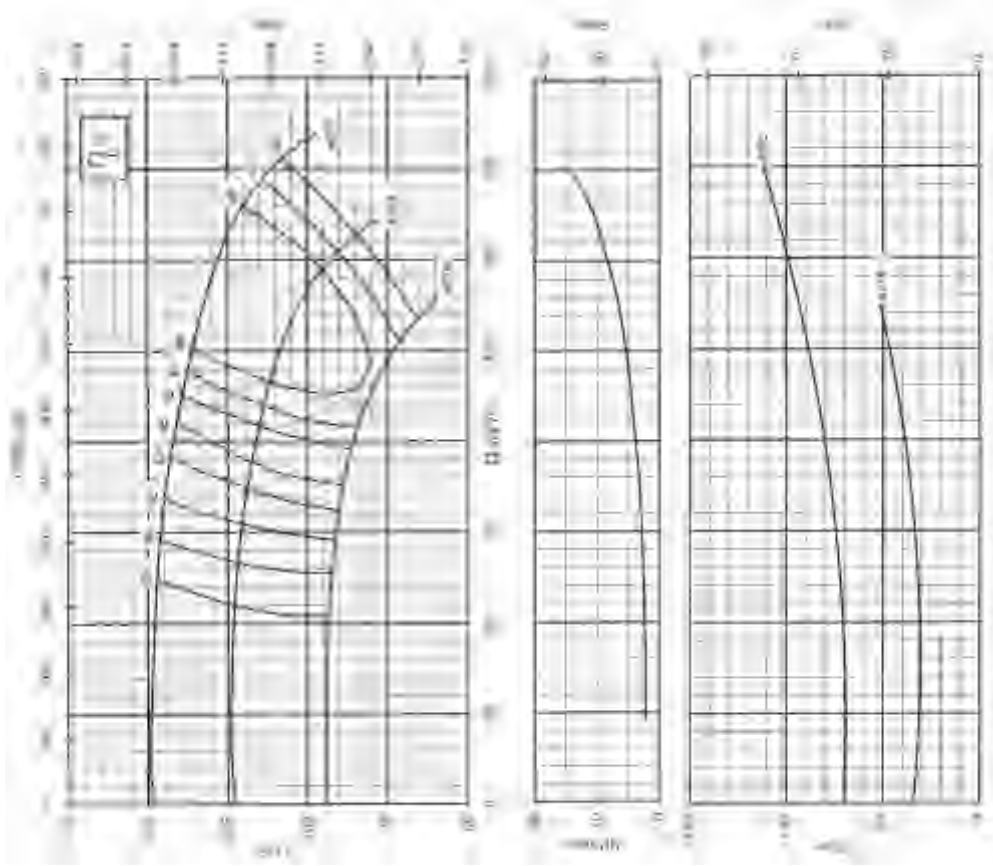

Impeller Ø Max.	273 mm	Suction Flange	100 mm
Impeller Ø Min.	216 mm	Pressure Flange	75 mm
Viscosity	$\mu = 1 \text{ cP}$	Specific Weight	$\gamma = 1 \text{ kgf/dm}^3$

BP 75-330 ROTOR "A" 1750 RPM

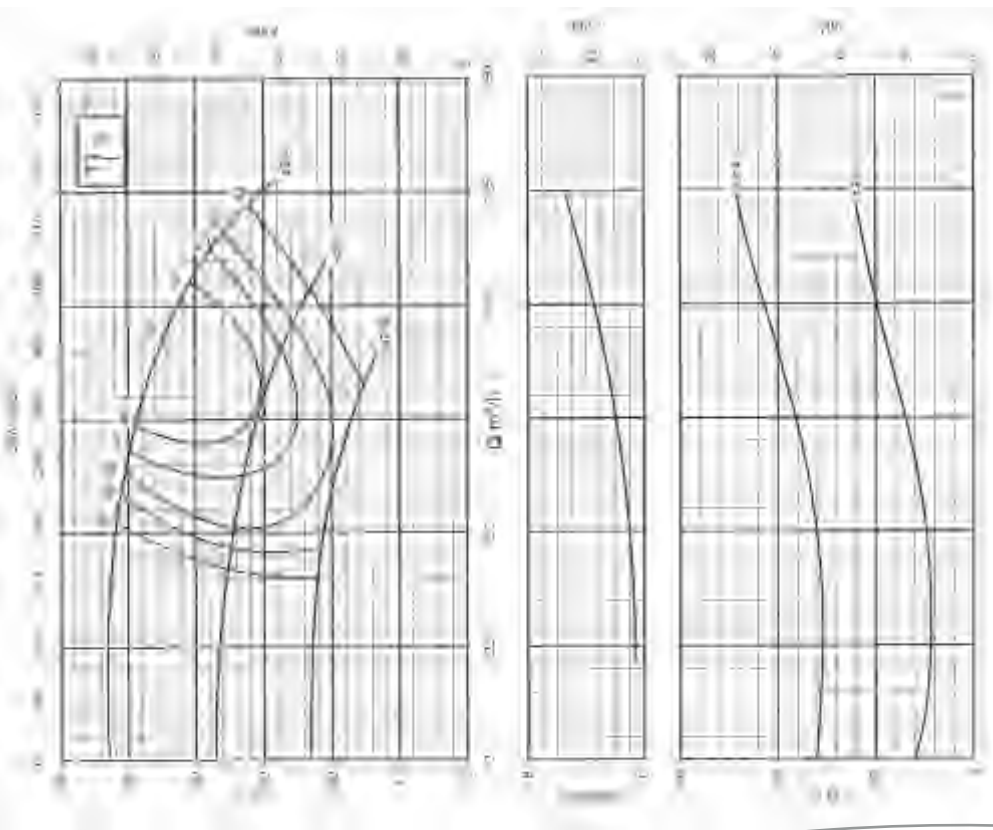

Impeller Ø Max.	314 mm	Suction Flange	100 mm
Impeller Ø Min.	216 mm	Pressure Flange	75 mm
Viscosity	$\mu = 1 \text{ cP}$	Specific Weight	$\gamma = 1 \text{ kgf/dm}^3$

BP 100-330 ROTOR "A" 3500 RPM

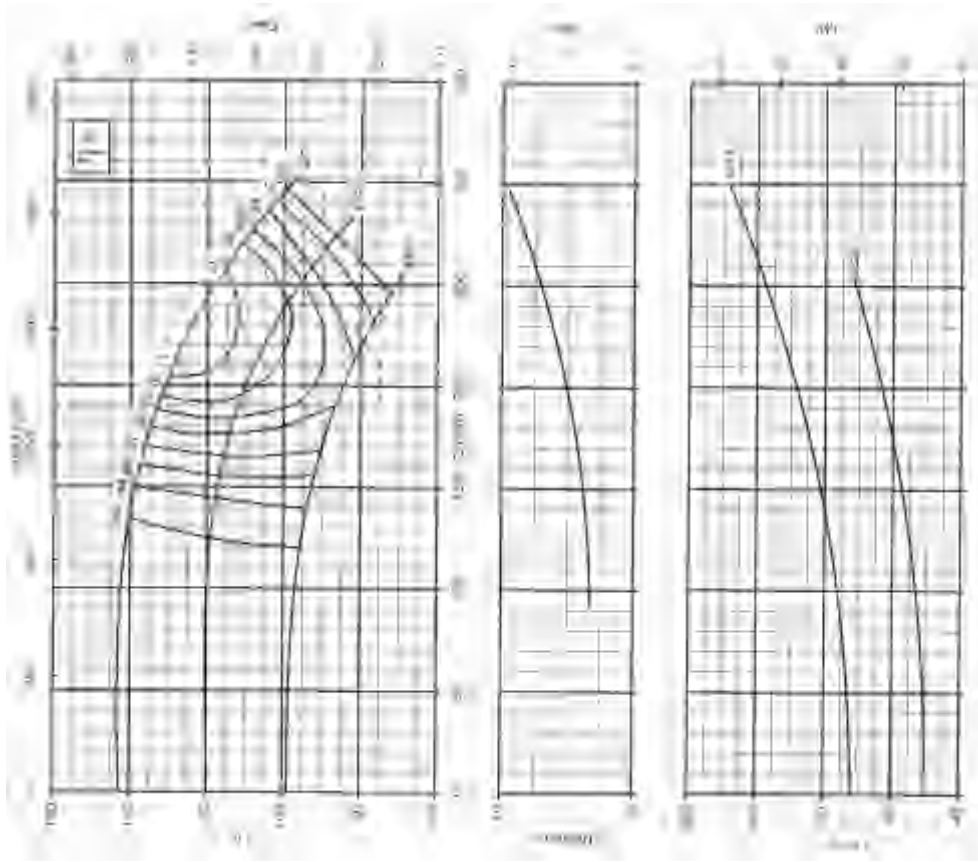

Impeller Ø Max.	273 mm	Suction Flange	150 mm
Impeller Ø Min.	229 mm	Pressure Flange	100 mm
Viscosity	$\mu = 1 \text{ cP}$	Specific Weight	$\gamma = 1 \text{ kgf/dm}^3$

BP 100-330 ROTOR "A" 1750 RPM

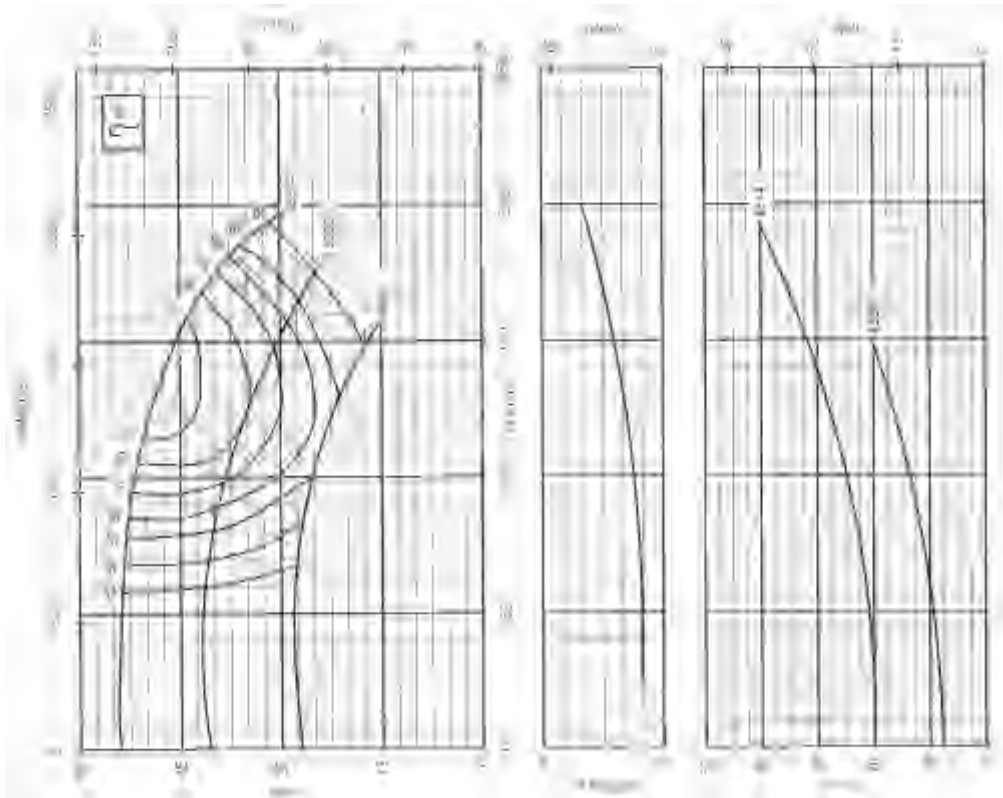

Impeller Ø Max.	314 mm	Suction Flange	150 mm
Impeller Ø Min.	229 mm	Pressure Flange	100 mm
Viscosity	$\mu = 1 \text{ cP}$	Specific Weight	$\gamma = 1 \text{ kgf/dm}^3$

BP 150-330 ROTOR "A" 3500 RPM

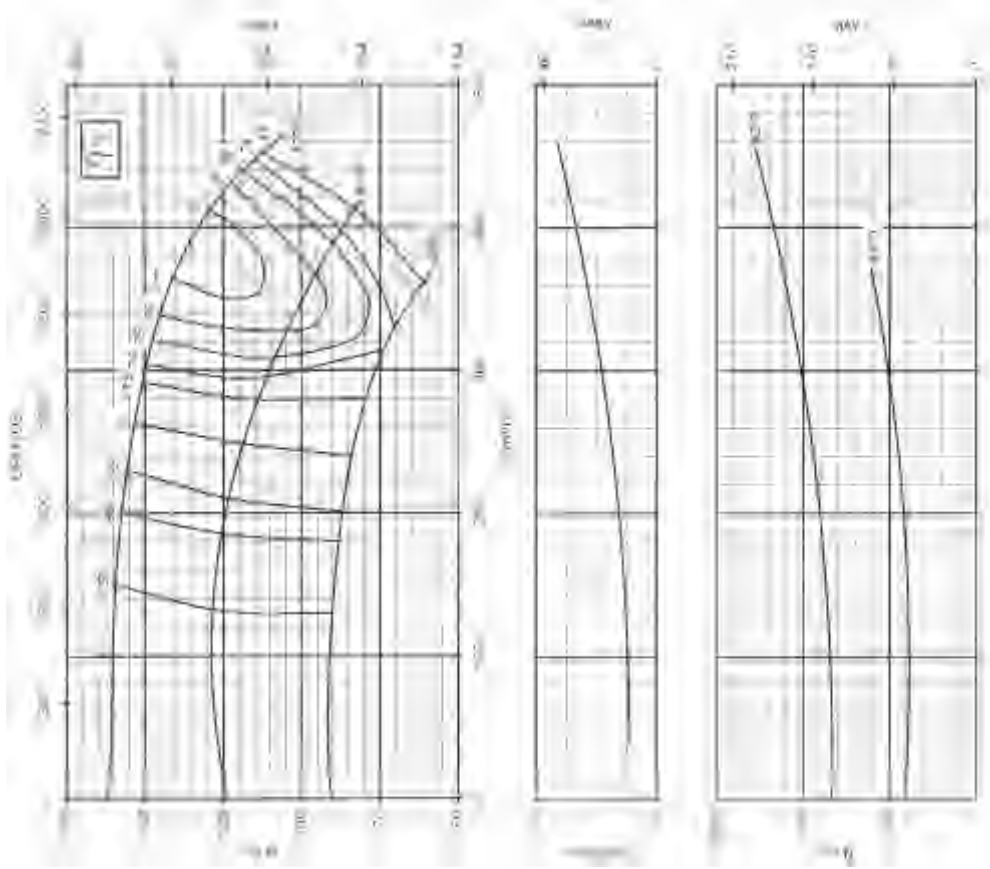

Impeller Ø Max.	279 mm	Suction Flange	200 mm
Impeller Ø Min.	203 mm	Pressure Flange	150 mm
Viscosity	$\mu = 1 \text{ cP}$	Specific Weight	$\gamma = 1 \text{ kgf/dm}^3$

BP 150-330 ROTOR "A" 1750 RPM

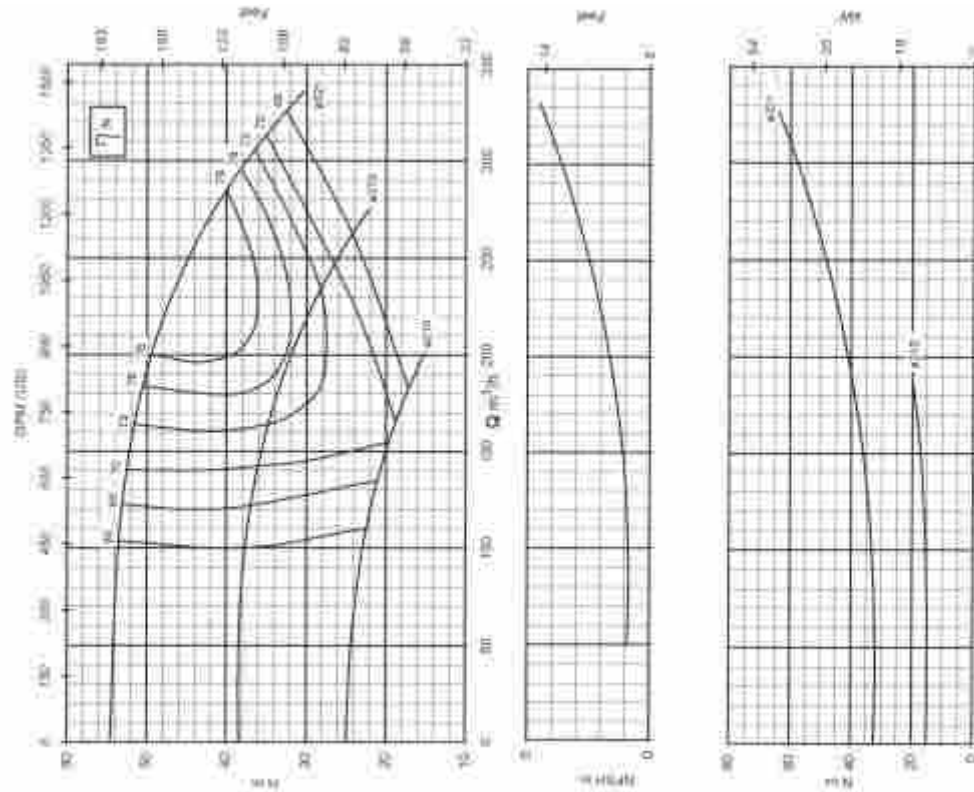

Impeller Ø Max.	321 mm	Suction Flange	200 mm
Impeller Ø Min.	210 mm	Pressure Flange	150 mm
Viscosity	$\mu = 1 \text{ cP}$	Specific Weight	$\gamma = 1 \text{ kgf/dm}^3$

BP 150-450 ROTOR "D" 1175 RPM

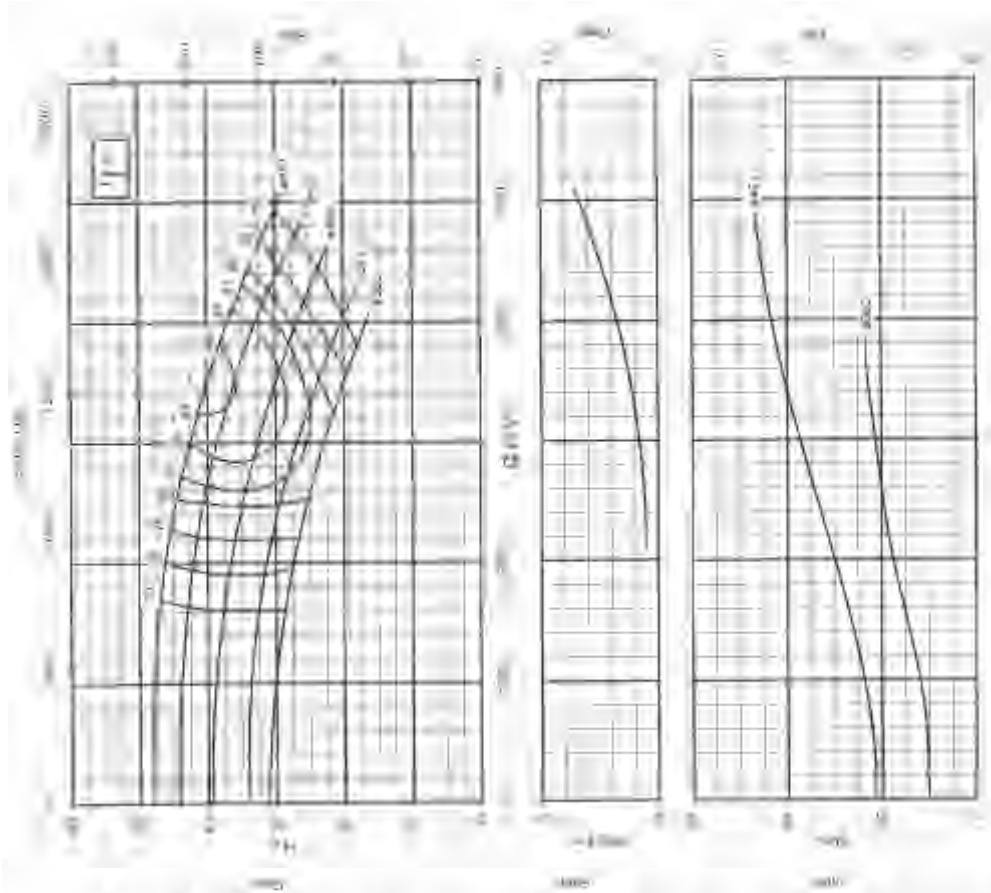

Impeller Ø Max.	451 mm	Suction Flange	250 mm
Impeller Ø Min.	362 mm	Pressure Flange	150 mm
Viscosity	$\mu = 1 \text{ cP}$	Specific Weight	$\gamma = 1 \text{ kgf/dm}^3$

BP 150-450 ROTOR "A" 1175 RPM

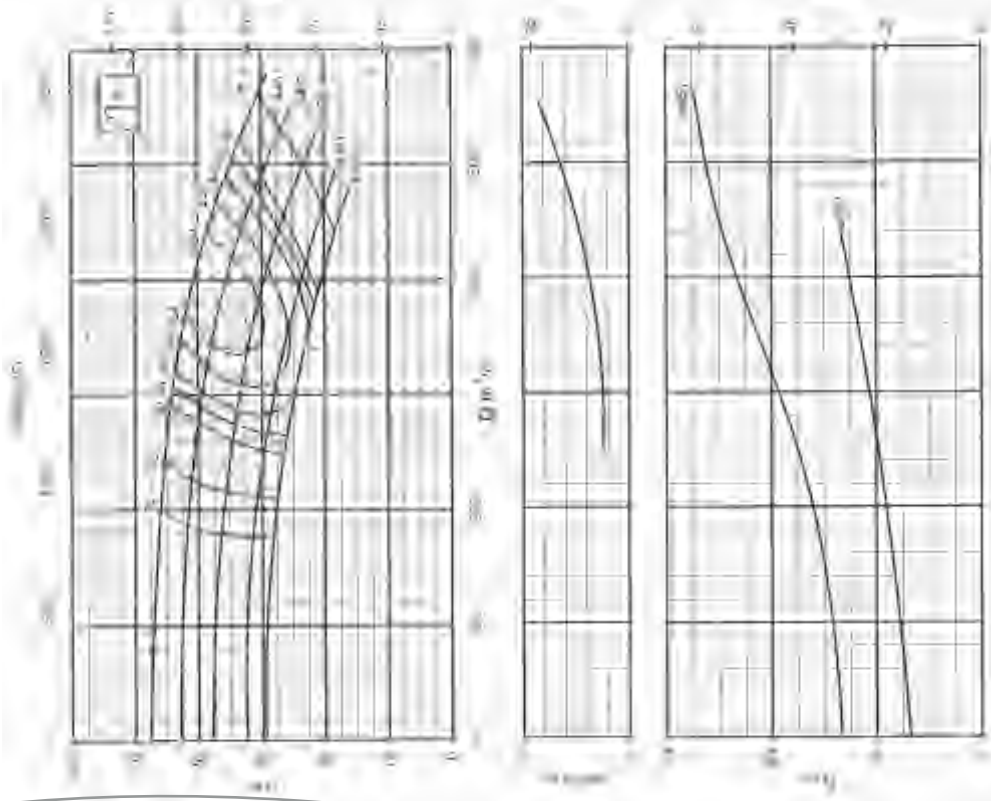

Impeller Ø Max.	451 mm	Suction Flange	250 mm
Impeller Ø Min.	362 mm	Pressure Flange	150 mm
Viscosity	$\mu = 1 \text{ cP}$	Specific Weight	$\gamma = 1 \text{ kgf/dm}^3$

BP 150-450 ROTOR "D" 1775 RPM

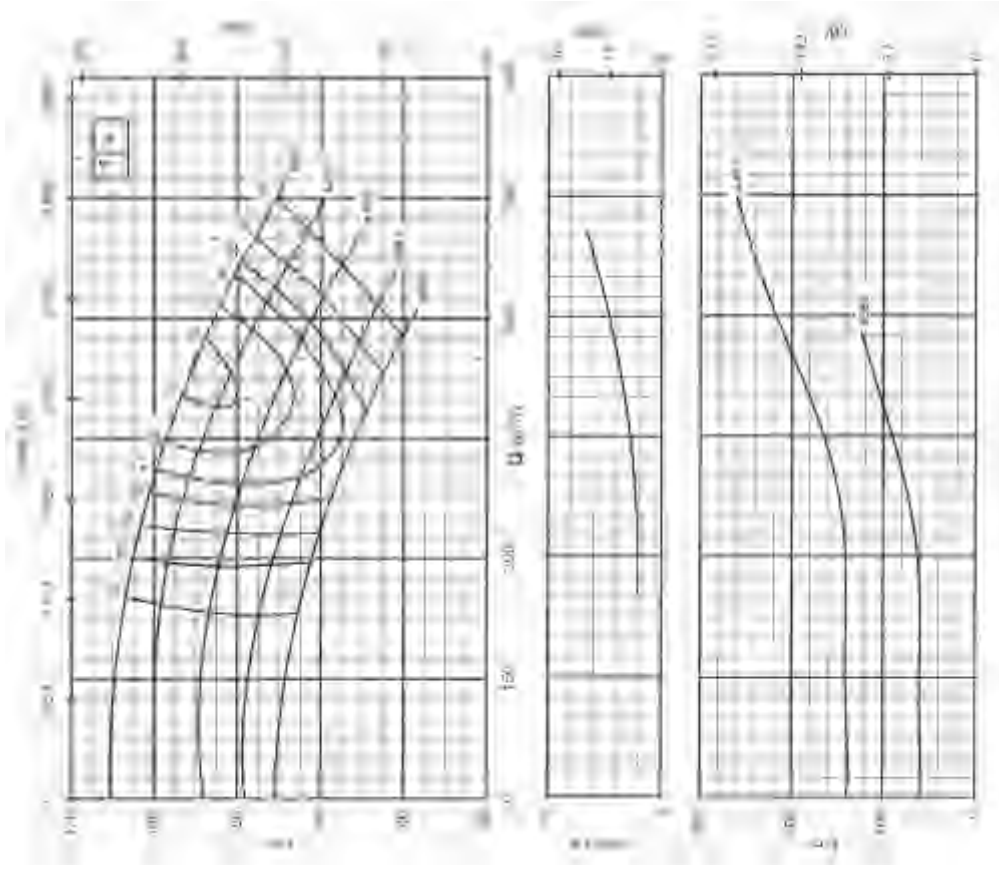

Impeller Ø Max.	451 mm	Suction Flange	250 mm
Impeller Ø Min.	362 mm	Pressure Flange	150 mm
Viscosity	$\mu = 1 \text{ cP}$	Specific Weight	$\gamma = 1 \text{ kgf/dm}^3$

BP 150-450 ROTOR "A" 1775 RPM

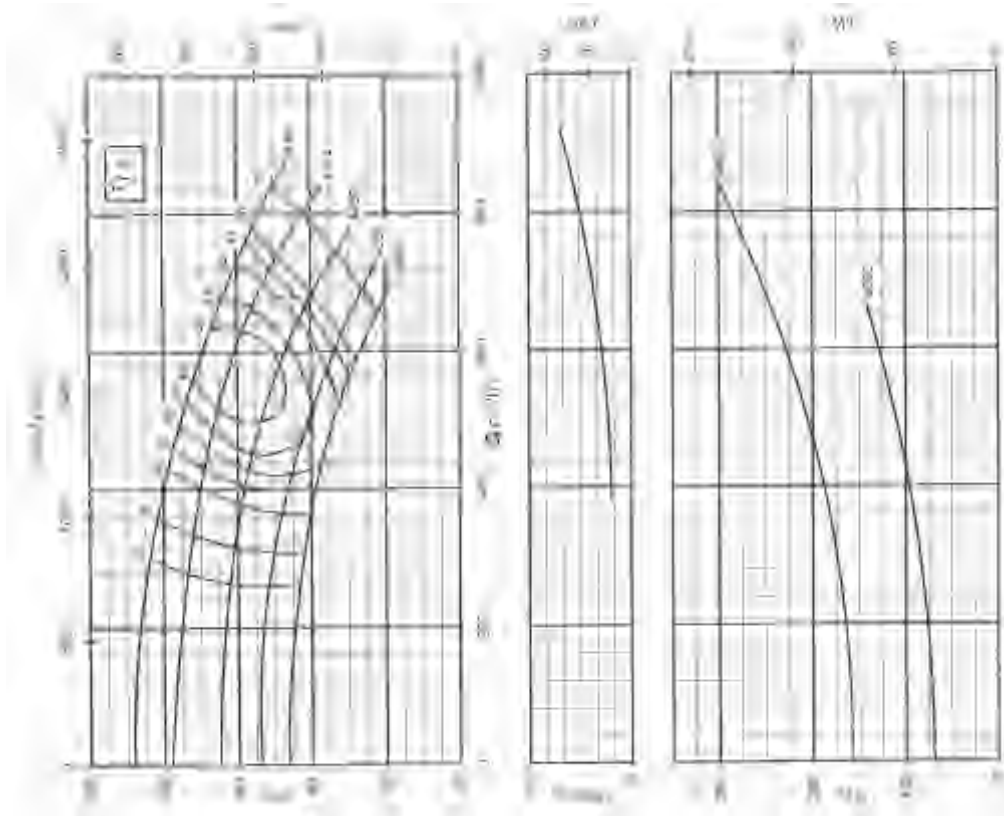

Impeller Ø Max.	451 mm	Suction Flange	250 mm
Impeller Ø Min.	362 mm	Pressure Flange	150 mm
Viscosity	$\mu = 1 \text{ cP}$	Specific Weight	$\gamma = 1 \text{ kgf/dm}^3$

BP 150-580 ROTOR "A" 1775 RPM

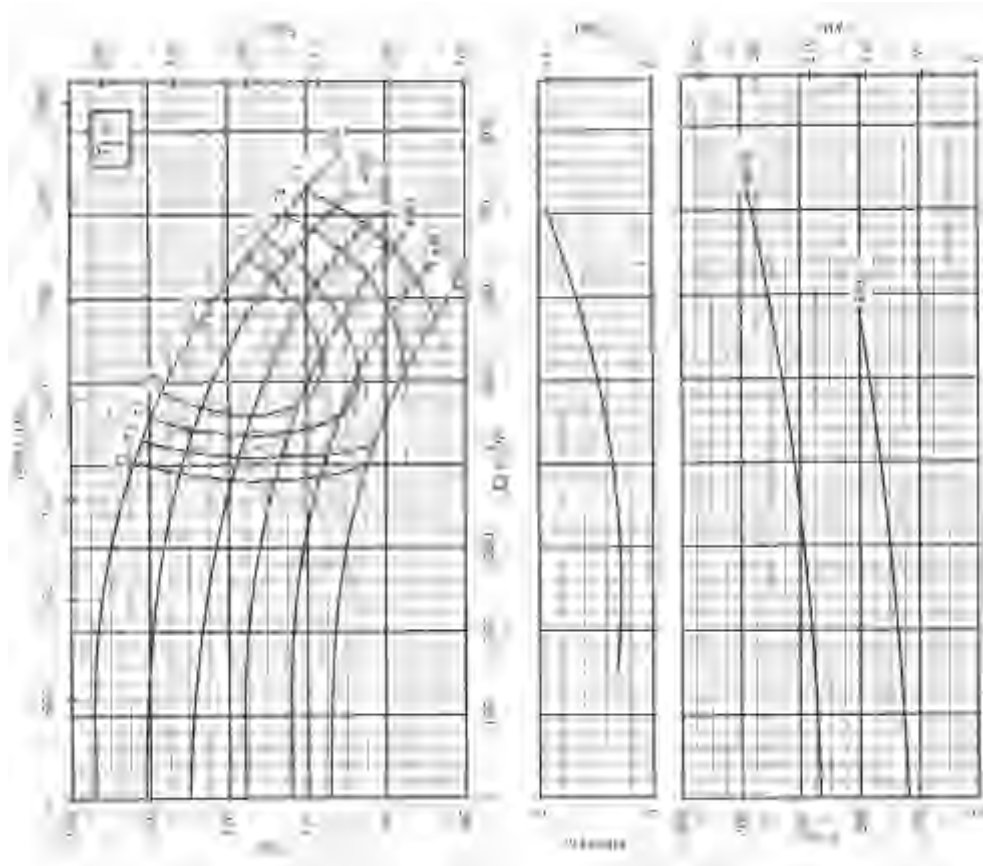

Impeller Ø Max.	559 mm	Suction Flange	250 mm
Impeller Ø Min.	432 mm	Pressure Flange	150 mm
Viscosity	$\mu = 1 \text{ cP}$	Specific Weight	$\gamma = 1 \text{ kgf/dm}^3$

BP 150-580 ROTOR "A" 1175 RPM

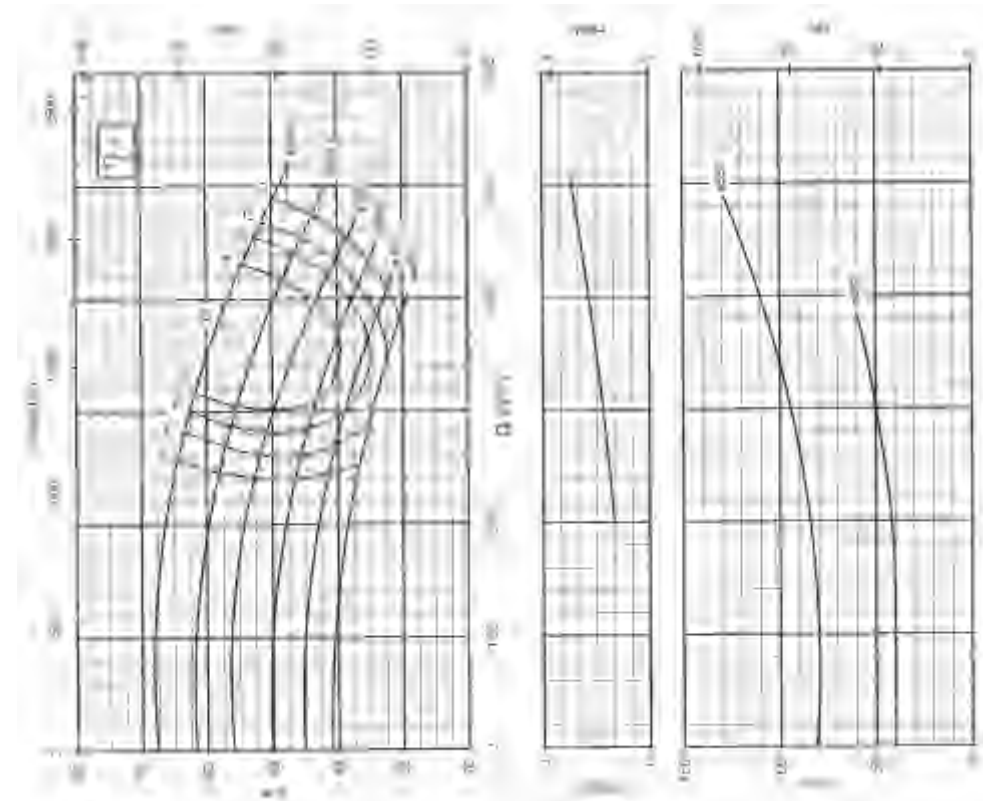

Impeller Ø Max.	559 mm	Suction Flange	250 mm
Impeller Ø Min.	432 mm	Pressure Flange	150 mm
Viscosity	$\mu = 1 \text{ cP}$	Specific Weight	$\gamma = 1 \text{ kgf/dm}^3$

BP 200-350 ROTOR "A" 1775 RPM

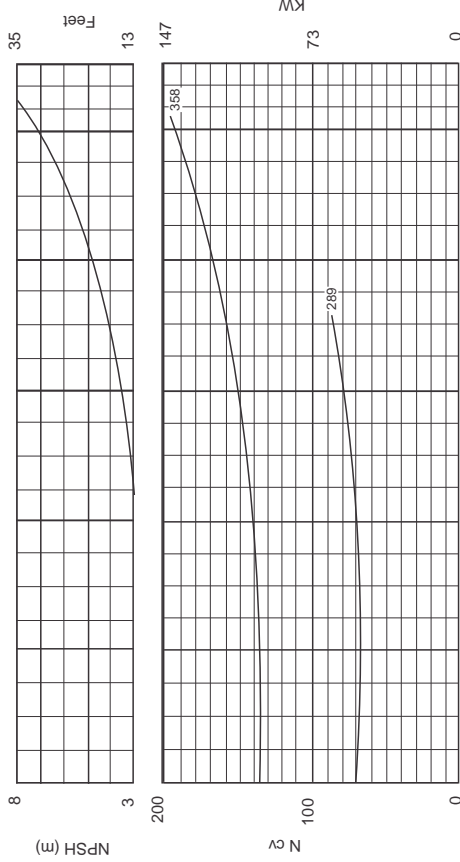
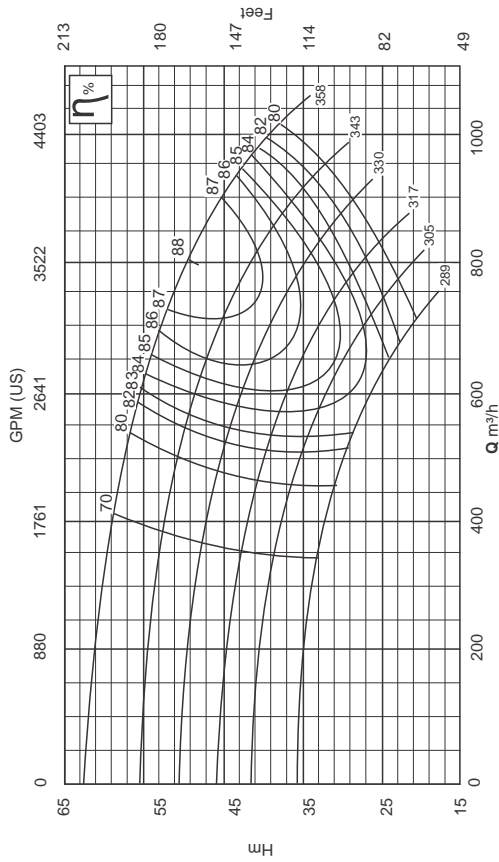

Impeller Ø Max.	358 mm	Suction Flange	300 mm
Impeller Ø Min.	289 mm	Pressure Flange	200 mm
Viscosity	$\mu = 1 \text{ cP}$	Specific Weight	$\gamma = 1 \text{ kgf/dm}^3$

BP 200-350 ROTOR "A" 1175 RPM

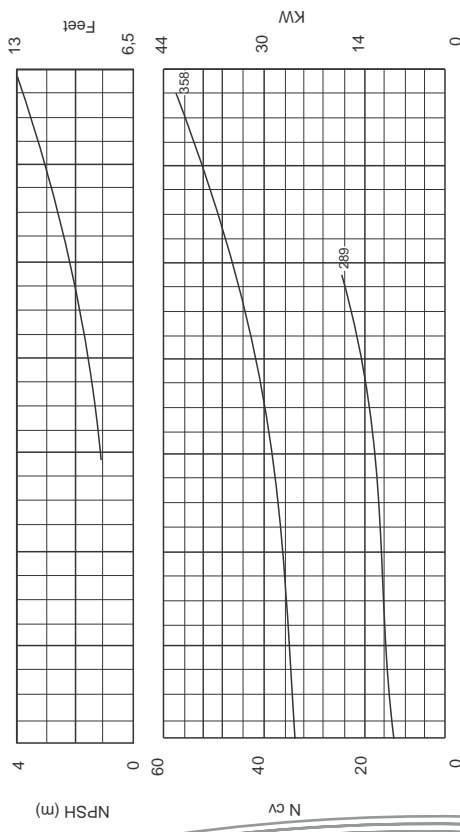
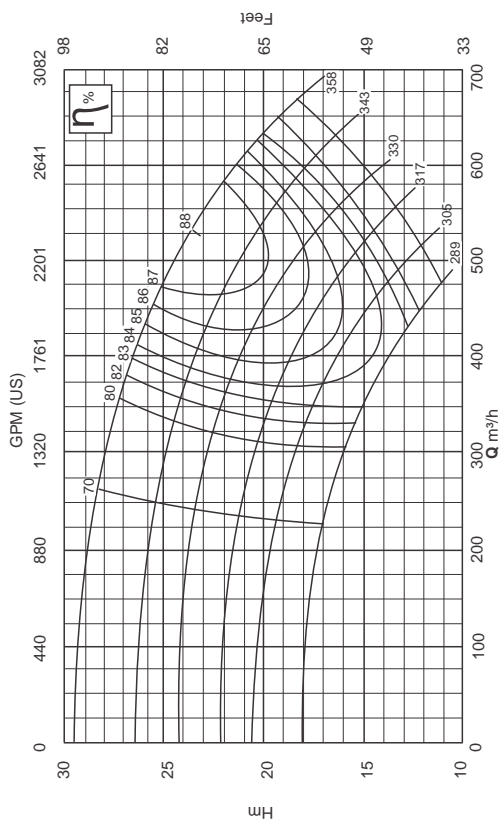

Impeller Ø Max.	358 mm	Suction Flange	300 mm
Impeller Ø Min.	289 mm	Pressure Flange	200 mm
Viscosity	$\mu = 1 \text{ cP}$	Specific Weight	$\gamma = 1 \text{ kgf/dm}^3$

BP 200-450 ROTOR "C" 1175 RPM

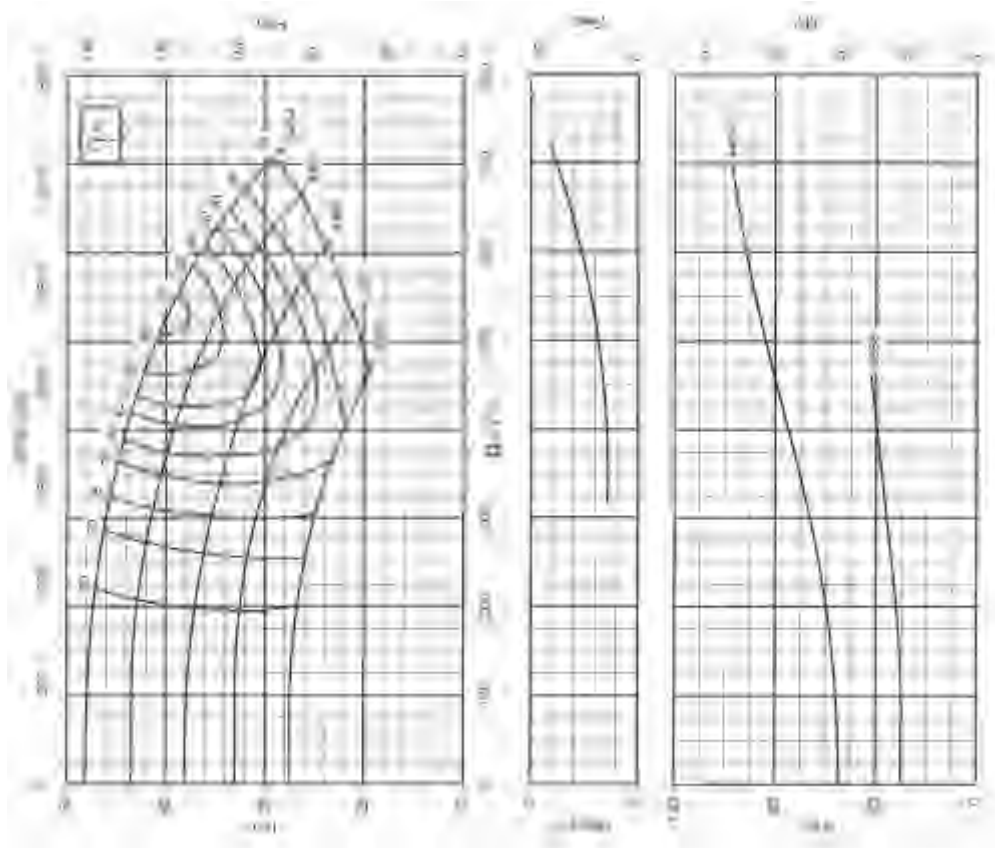

Impeller Ø Max.	454 mm	Suction Flange	300 mm
Impeller Ø Min.	356 mm	Pressure Flange	200 mm
Viscosity	$\mu = 1 \text{ cP}$	Specific Weight	$\gamma = 1 \text{ kgf/dm}^3$

BP 200-450 ROTOR "A" 1175 RPM

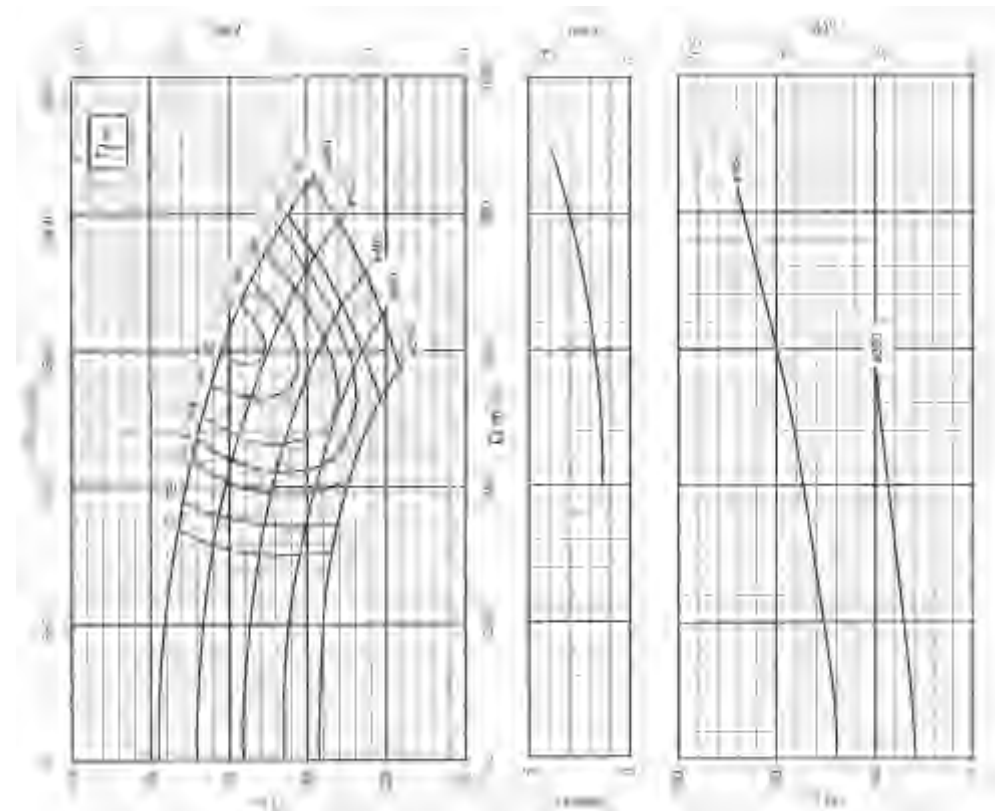

Impeller Ø Max.	454 mm	Suction Flange	300 mm
Impeller Ø Min.	356 mm	Pressure Flange	200 mm
Viscosity	$\mu = 1 \text{ cP}$	Specific Weight	$\gamma = 1 \text{ kgf/dm}^3$

BP 200-450 ROTOR "C" 1775 RPM

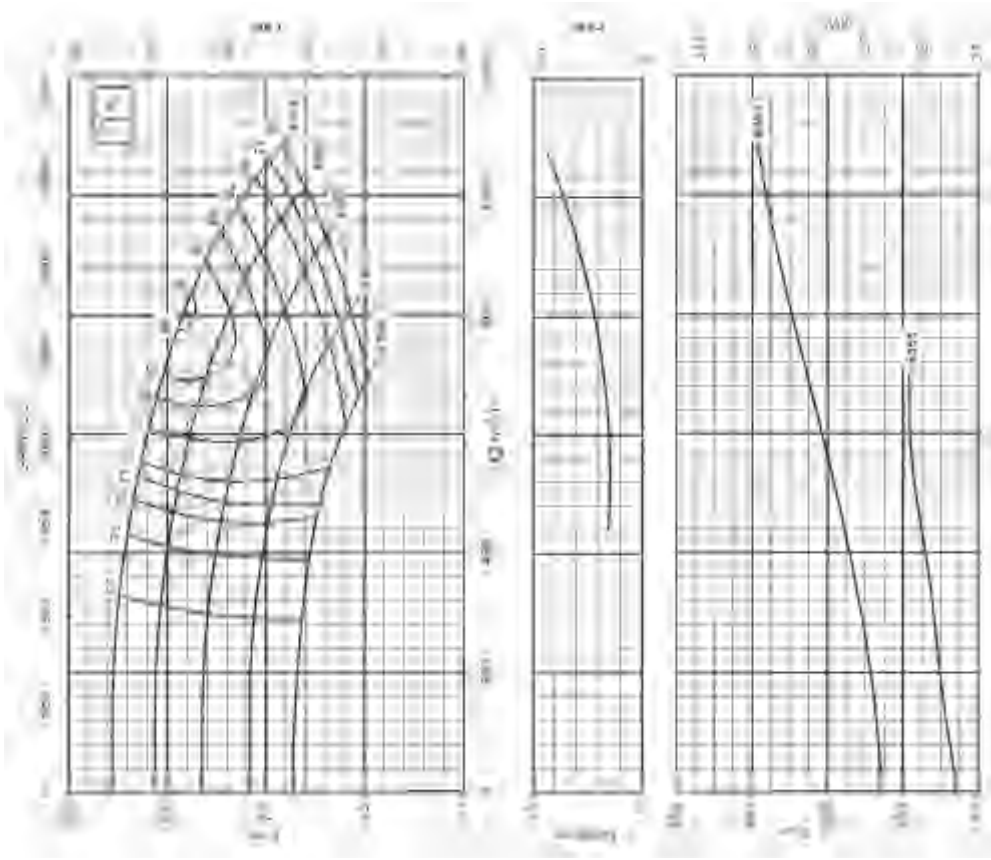

Impeller Ø Max.	454 mm	Suction Flange	300 mm
Impeller Ø Min.	356 mm	Pressure Flange	200 mm
Viscosity	$\mu = 1 \text{ cP}$	Specific Weight	$\gamma = 1 \text{ kgf/dm}^3$

BP 200-450 ROTOR "A" 1775 RPM

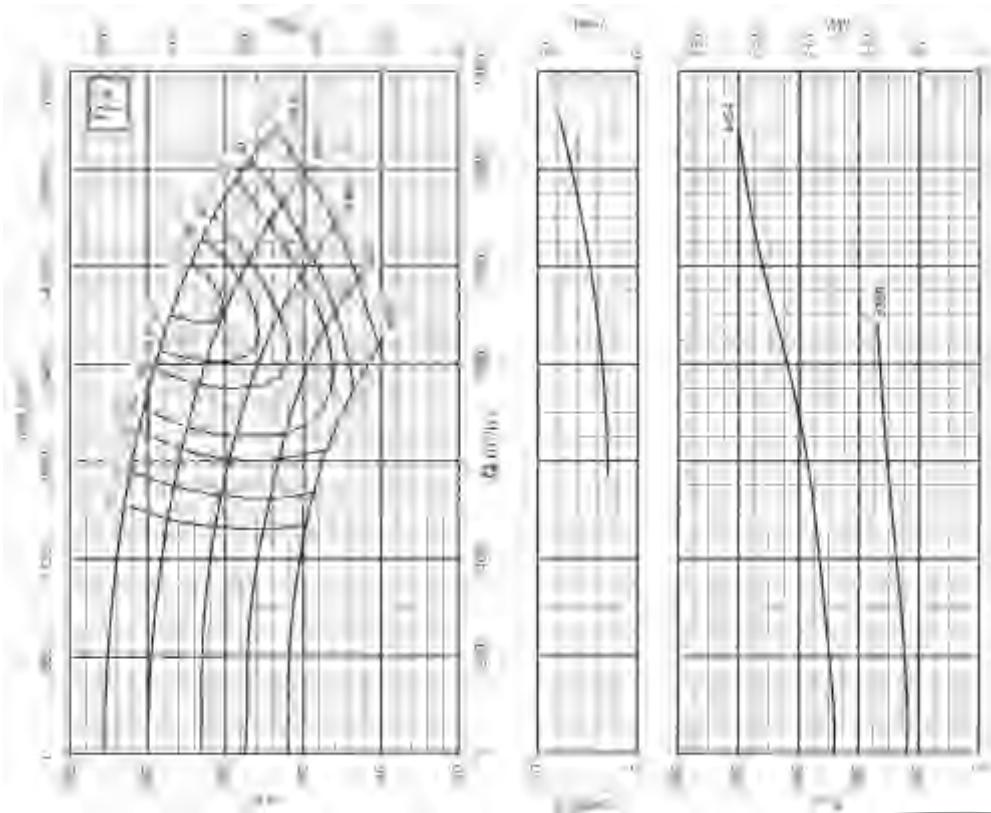

Impeller Ø Max.	454 mm	Suction Flange	300 mm
Impeller Ø Min.	356 mm	Pressure Flange	200 mm
Viscosity	$\mu = 1 \text{ cP}$	Specific Weight	$\gamma = 1 \text{ kgf/dm}^3$

BP 200-530 ROTOR “E” 1775 RPM

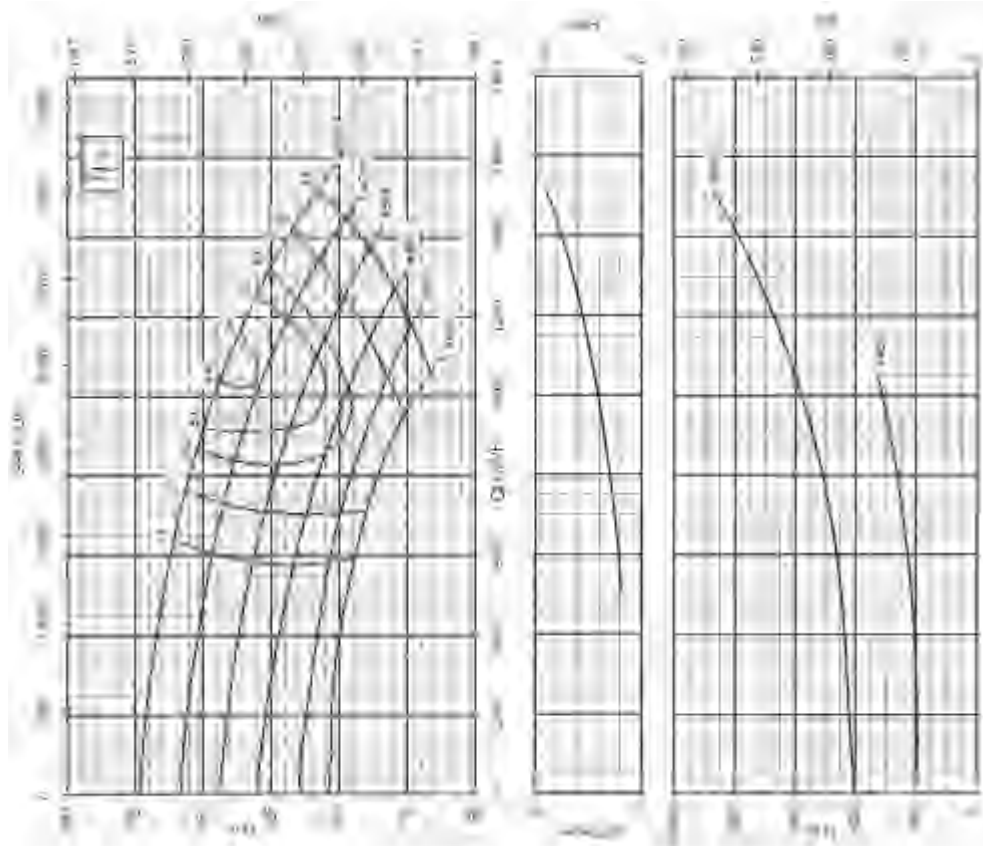

Impeller Ø Max.	559 mm	Suction Flange	350 mm
Impeller Ø Min.	438 mm	Pressure Flange	200 mm
Viscosity	$\mu = 1 \text{ cP}$	Specific Weight	$\gamma = 1 \text{ kgf/dm}^3$

BP 200-530 ROTOR “E” 1775 RPM

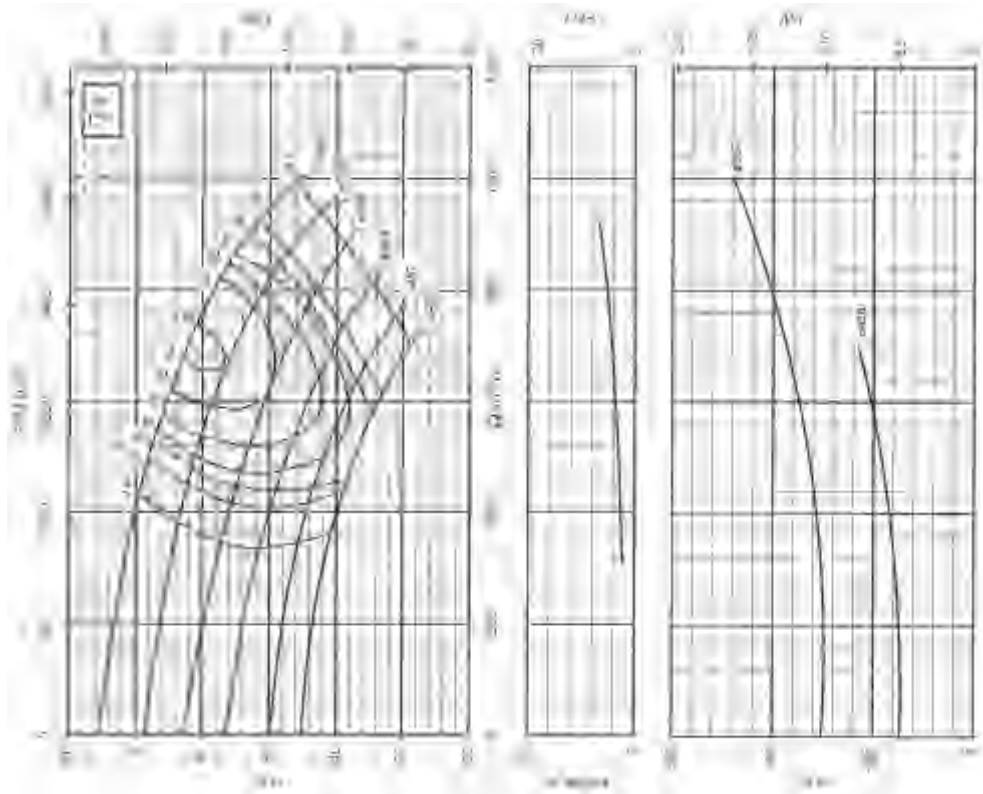

Impeller Ø Max.	559 mm	Suction Flange	350 mm
Impeller Ø Min.	438 mm	Pressure Flange	200 mm
Viscosity	$\mu = 1 \text{ cP}$	Specific Weight	$\gamma = 1 \text{ kgf/dm}^3$

BP 250-400 ROTOR "A" 1775 RPM

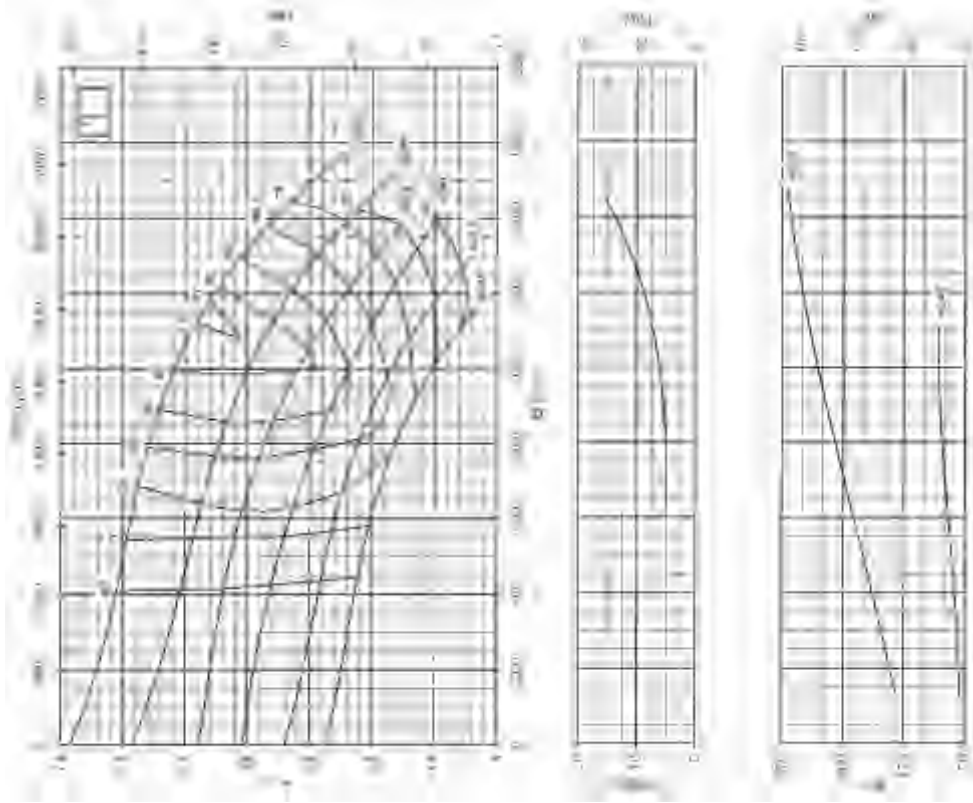

Impeller Ø Max.	375 mm	Suction Flange	300 mm
Impeller Ø Min.	248 mm	Pressure Flange	250 mm
Viscosity	$\mu = 1 \text{ cP}$	Specific Weight	$\gamma = 1 \text{ kgf/dm}^3$

BP 250-400 ROTOR "A" 1775 RPM

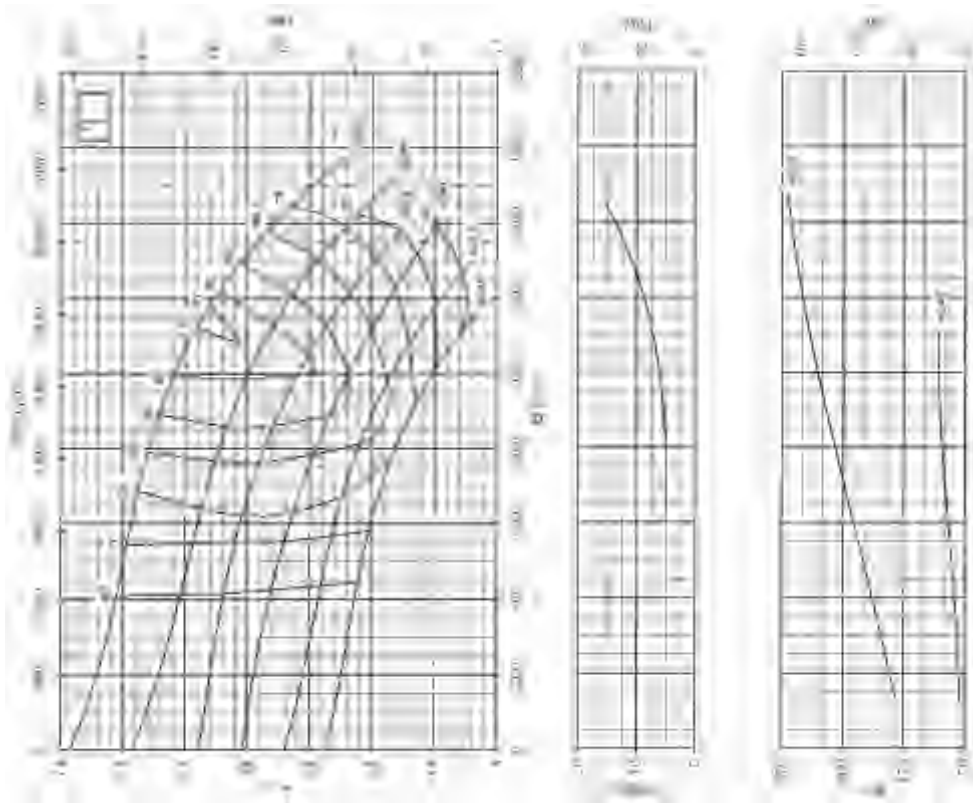

Impeller Ø Max.	375 mm	Suction Flange	300 mm
Impeller Ø Min.	248 mm	Pressure Flange	250 mm
Viscosity	$\mu = 1 \text{ cP}$	Specific Weight	$\gamma = 1 \text{ kgf/dm}^3$

BP 250-550 ROTOR "A" 1175 RPM

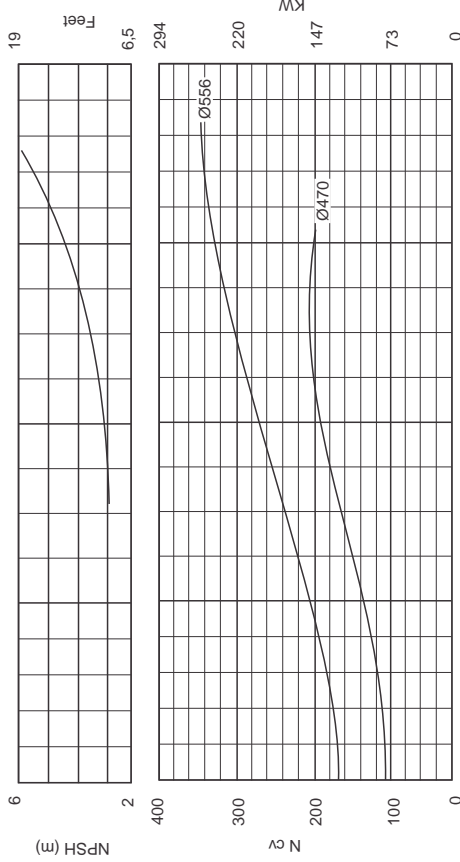
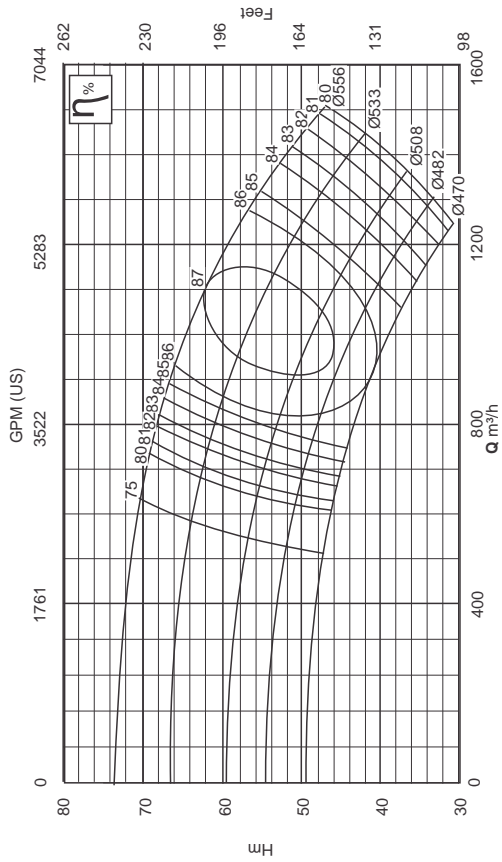

Impeller Ø Max.	555 mm	Suction Flange	350 mm
Impeller Ø Min.	469 mm	Pressure Flange	250 mm
Viscosity	$\mu = 1 \text{ cP}$	Specific Weight	$\gamma = 1 \text{ kg/dm}^3$

BP 250-550 ROTOR "A" 880 RPM

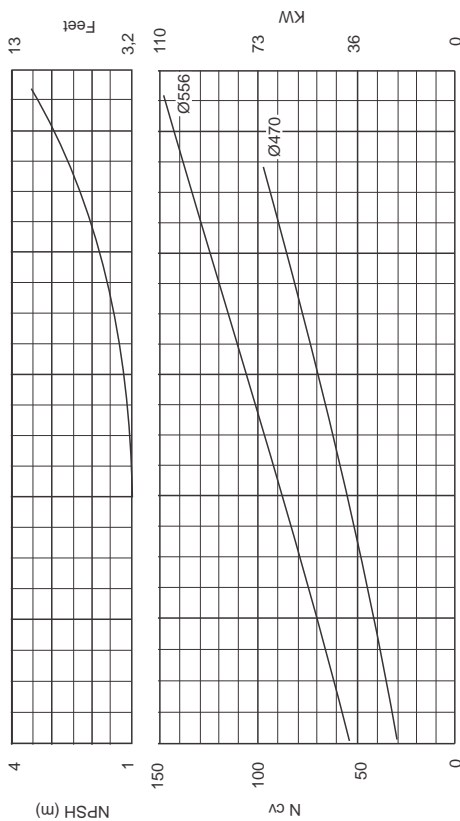
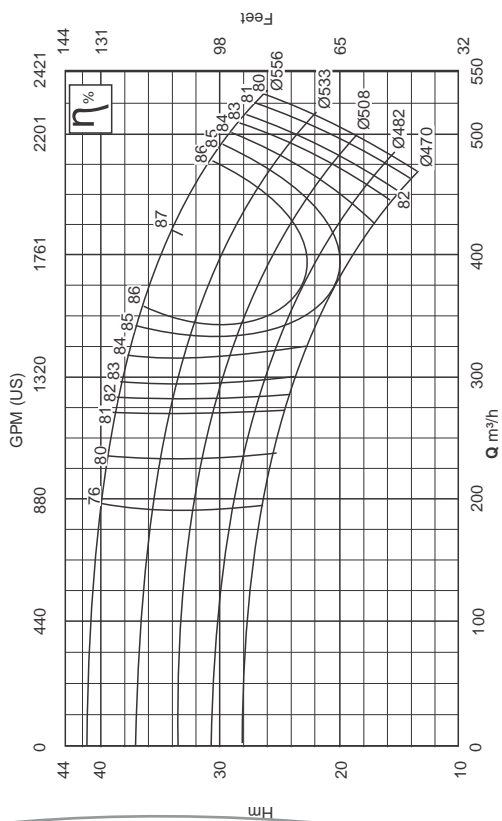

Impeller Ø Max.	555 mm	Suction Flange	350 mm
Impeller Ø Min.	469 mm	Pressure Flange	250 mm
Viscosity	$\mu = 1 \text{ cP}$	Specific Weight	$\gamma = 1 \text{ kg/dm}^3$

BP 250-700 ROTOR "B" 1750 RPM

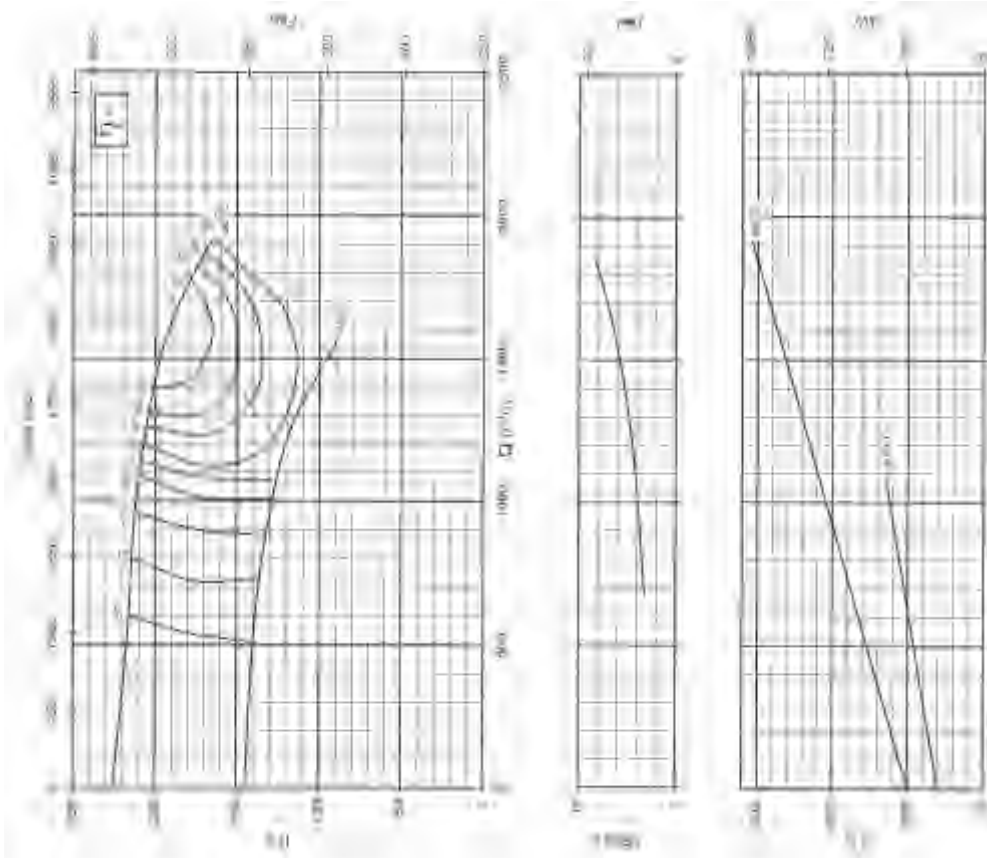

Impeller Ø Max.	670 mm	Suction Flange	350 mm
Impeller Ø Min.	530 mm	Pressure Flange	250 mm
Viscosity	$\mu = 1 \text{ cP}$	Specific Weight	$\gamma = 1 \text{ kgf/dm}^3$

BP 250-700 ROTOR "A" 1750 RPM

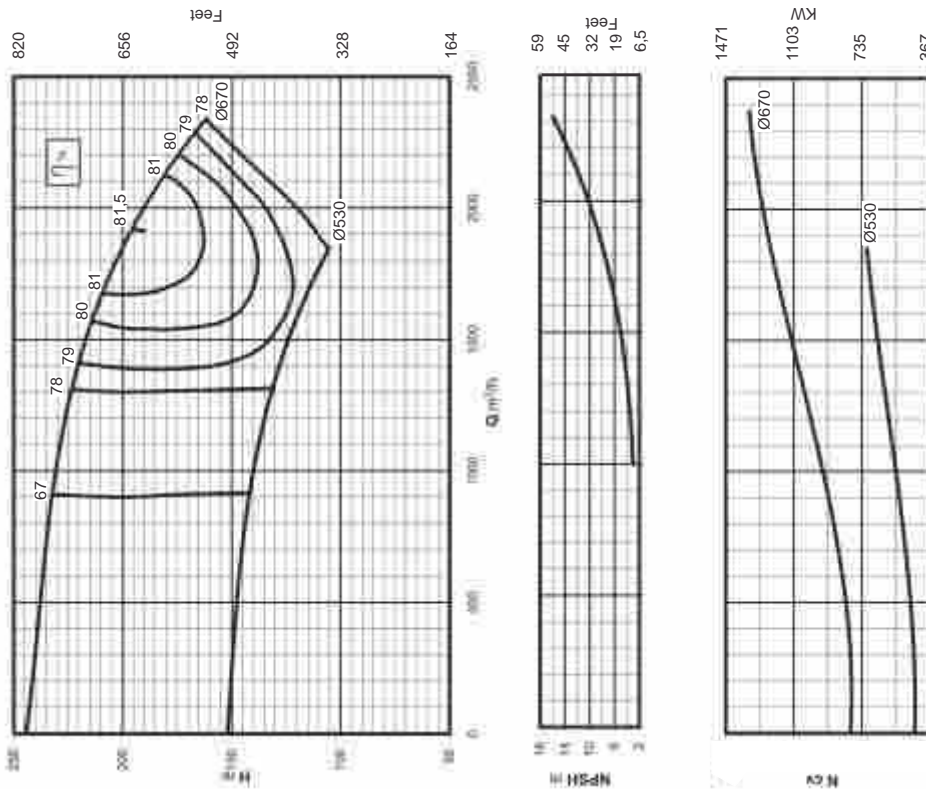

Impeller Ø Max.	670 mm	Suction Flange	350 mm
Impeller Ø Min.	530 mm	Pressure Flange	250 mm
Viscosity	$\mu = 1 \text{ cP}$	Specific Weight	$\gamma = 1 \text{ kgf/dm}^3$

BP 300-340 ROTOR "B" 1160 RPM

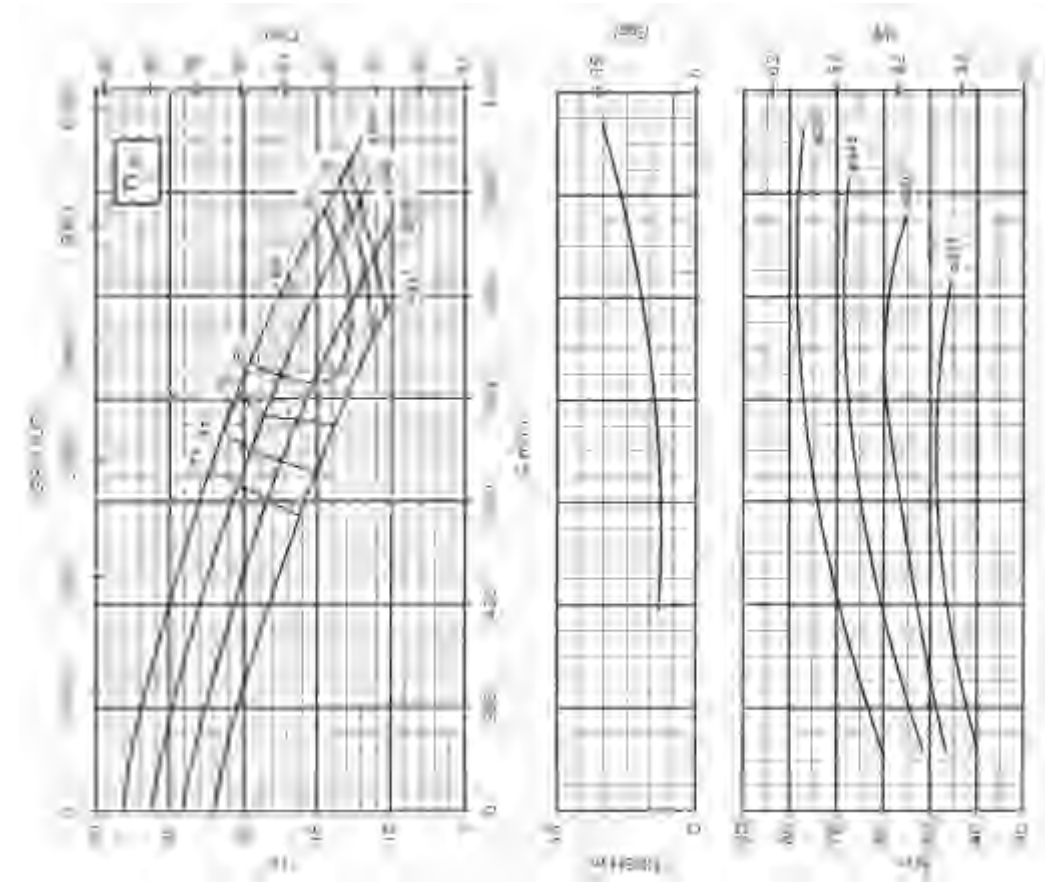

Impeller Ø Max.	358 mm	Suction Flange	350 mm
Impeller Ø Min.	315 mm	Pressure Flange	300 mm
Viscosity	$\mu = 1 \text{ cP}$	Specific Weight	$\gamma = 1 \text{ kgf/dm}^3$

BP 300-340 ROTOR "A" 1160 RPM

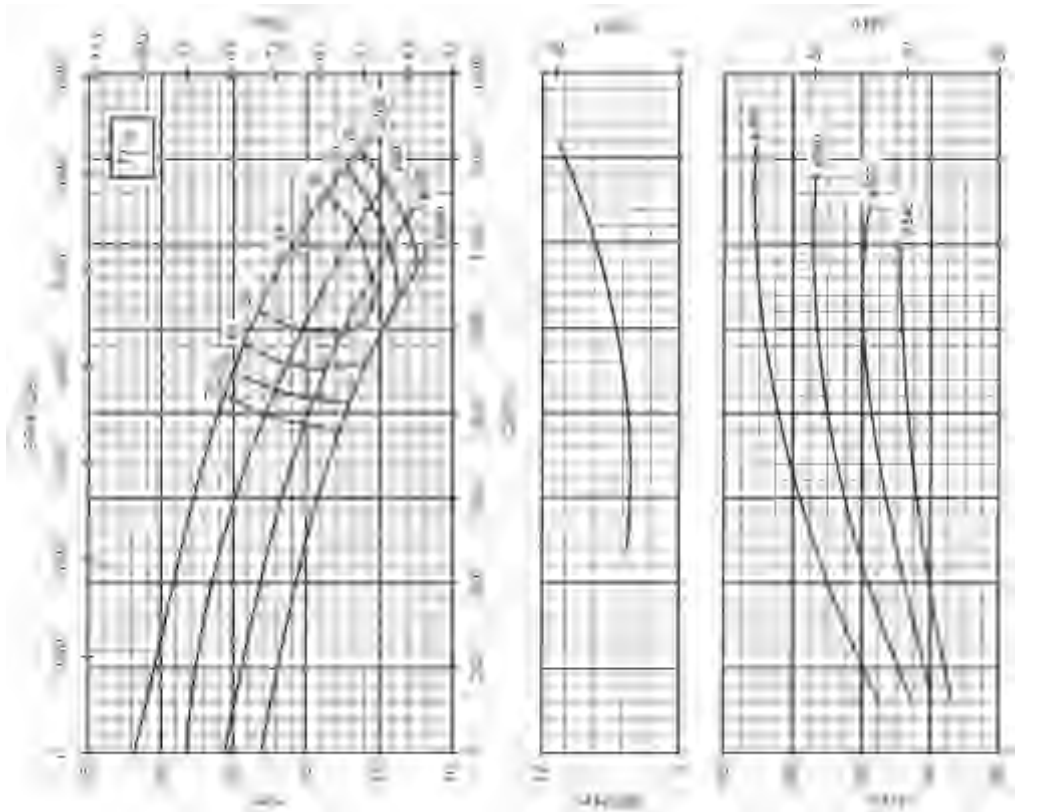

Impeller Ø Max.	400 mm	Suction Flange	350 mm
Impeller Ø Min.	340 mm	Pressure Flange	300 mm
Viscosity	$\mu = 1 \text{ cP}$	Specific Weight	$\gamma = 1 \text{ kgf/dm}^3$

BP 300-340 ROTOR "B" 1750 RPM

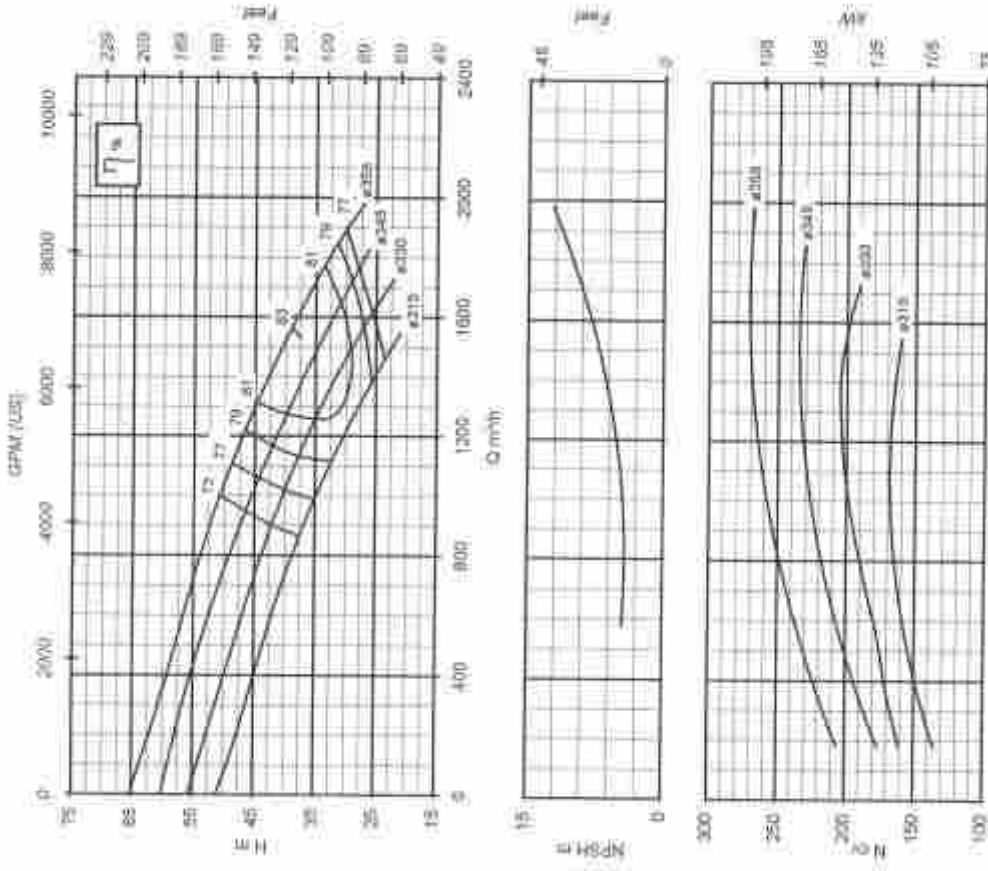

Impeller Ø Max.	358 mm	Suction Flange	350 mm
Impeller Ø Min.	315 mm	Pressure Flange	300 mm
Viscosity	$\mu = 1$ cP	Specific Weight	$\gamma = 1$ kgf/dm ³

BP 300-340 ROTOR "A" 1750 RPM

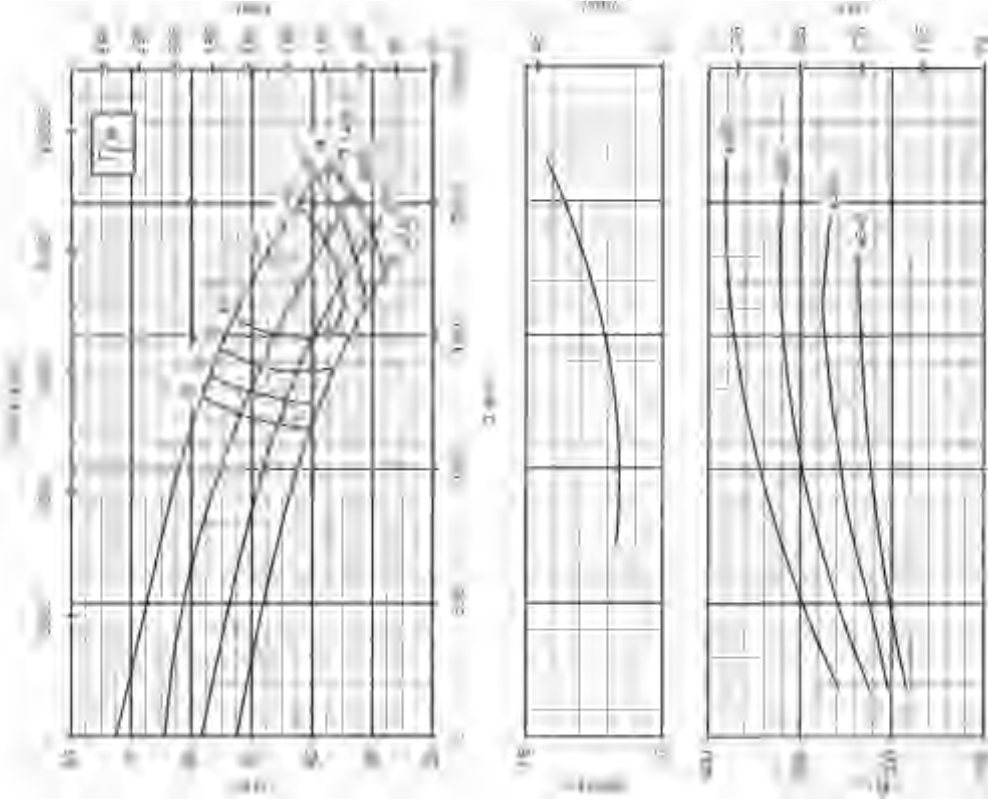

Impeller Ø Max.	400 mm	Suction Flange	350 mm
Impeller Ø Min.	340 mm	Pressure Flange	300 mm
Viscosity	$\mu = 1$ cP	Specific Weight	$\gamma = 1$ kgf/dm ³

BP 300-400 ROTOR "A" 1750 RPM

BP 300-400 ROTOR "A" 1750 RPM

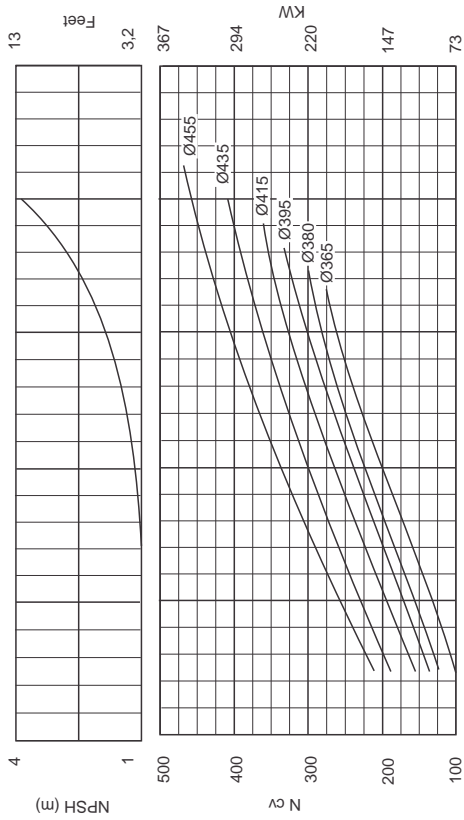
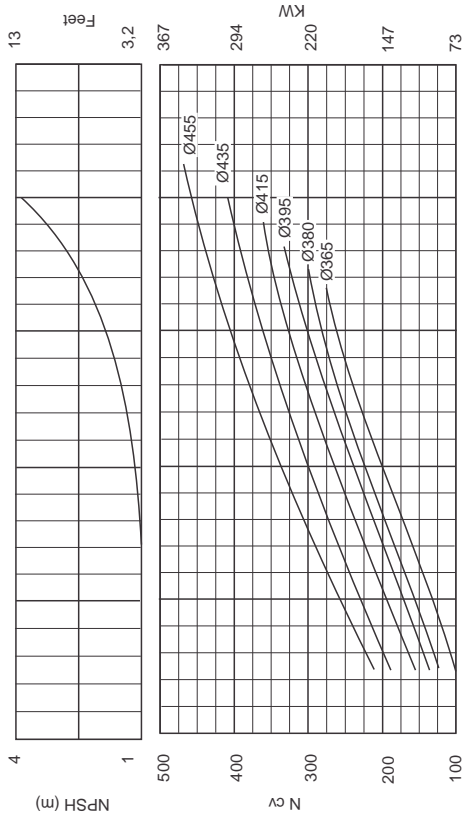
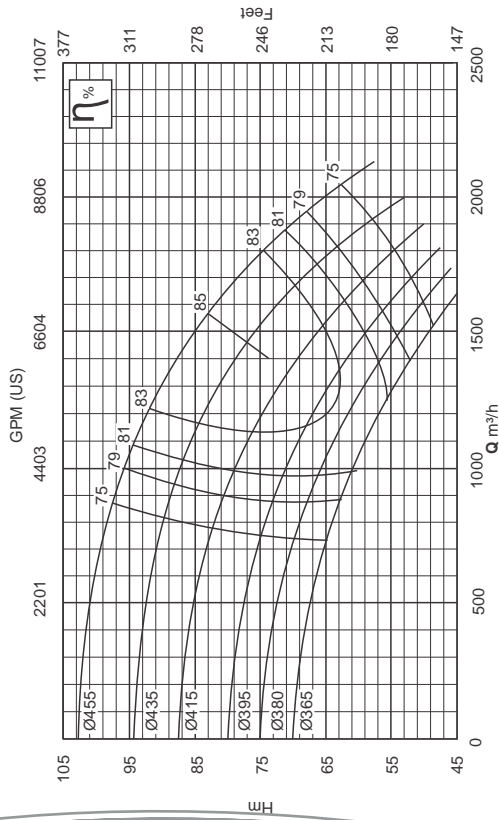
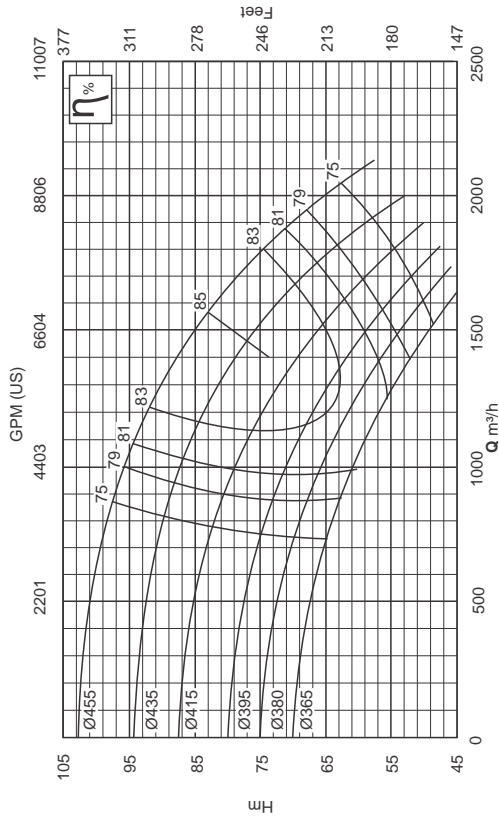

Impeller Ø Max. 455 mm Suction Flange 350 mm

Impeller Ø Min. 365 mm Pressure Flange 300 mm

Viscosity $\mu = 1 \text{ cP}$ Specific Weight $\gamma = 1 \text{ kg/dm}^3$

Impeller Ø Max. 455 mm Suction Flange 350 mm

Impeller Ø Min. 365 mm Pressure Flange 300 mm

Viscosity $\mu = 1 \text{ cP}$ Specific Weight $\gamma = 1 \text{ kg/dm}^3$

BP 300-660 ROTOR "A" 1175 RPM

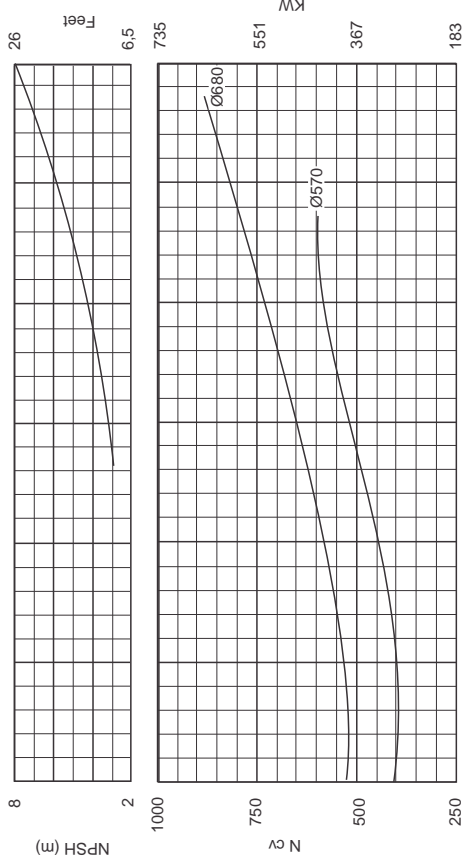
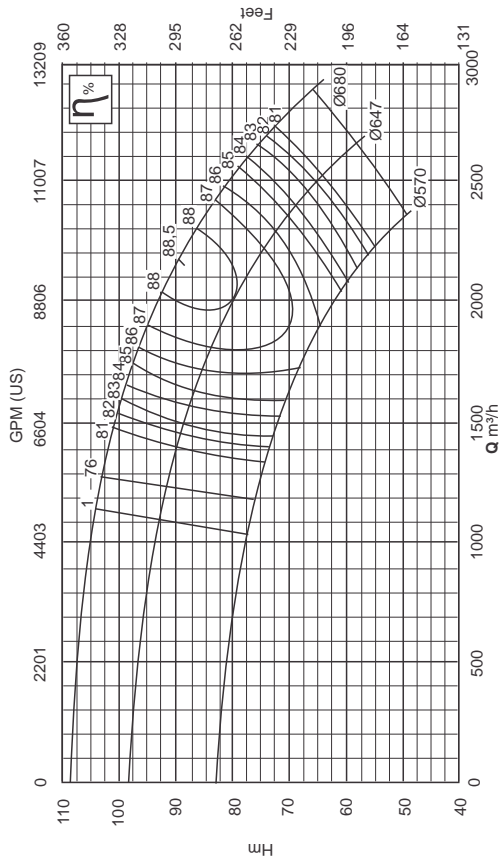

Impeller Ø Max.	679 mm	Suction Flange	450 mm
Impeller Ø Min.	597 mm	Pressure Flange	300 mm
Viscosity	$\mu = 1 \text{ cP}$	Specific Weight	$\gamma = 1 \text{ kgf/dm}^3$

BP 300-660 ROTOR "A" 880 RPM

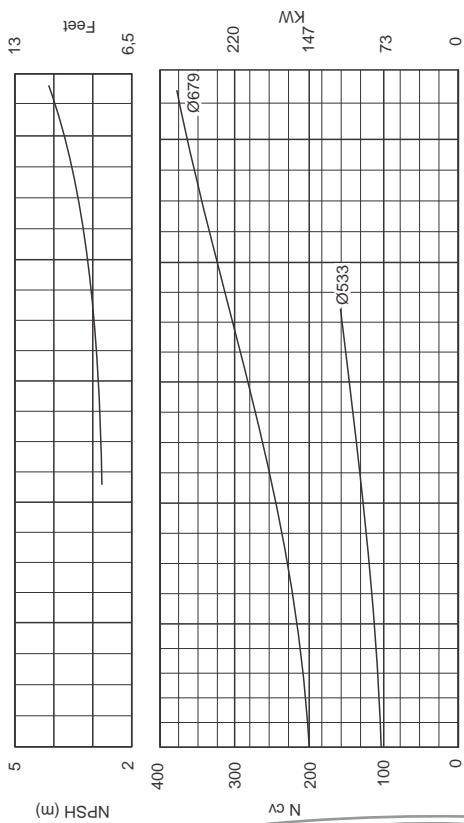
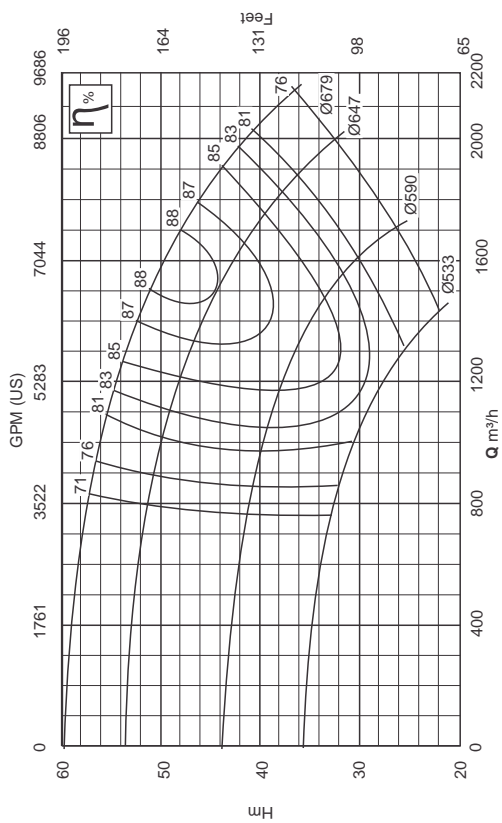

Impeller Ø Max.	679 mm	Suction Flange	450 mm
Impeller Ø Min.	533 mm	Pressure Flange	300 mm
Viscosity	$\mu = 1 \text{ cP}$	Specific Weight	$\gamma = 1 \text{ kgf/dm}^3$

BP 400-390 ROTOR "B" 1750 RPM

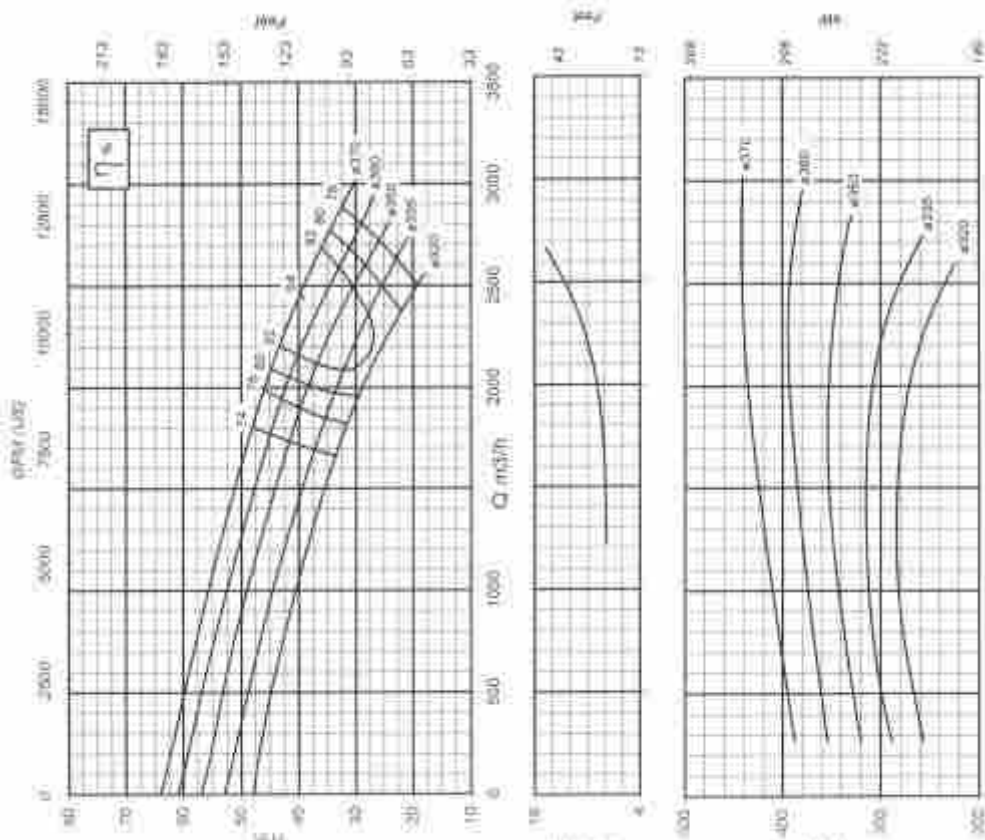

Impeller Ø Max.	370 mm	Suction Flange	500 mm
Impeller Ø Min.	320 mm	Pressure Flange	400 mm
Viscosity	$\mu = 1 \text{ cP}$	Specific Weight	$\gamma = 1 \text{ kgf/dm}^3$

BP 400-390 ROTOR "A" 1750 RPM

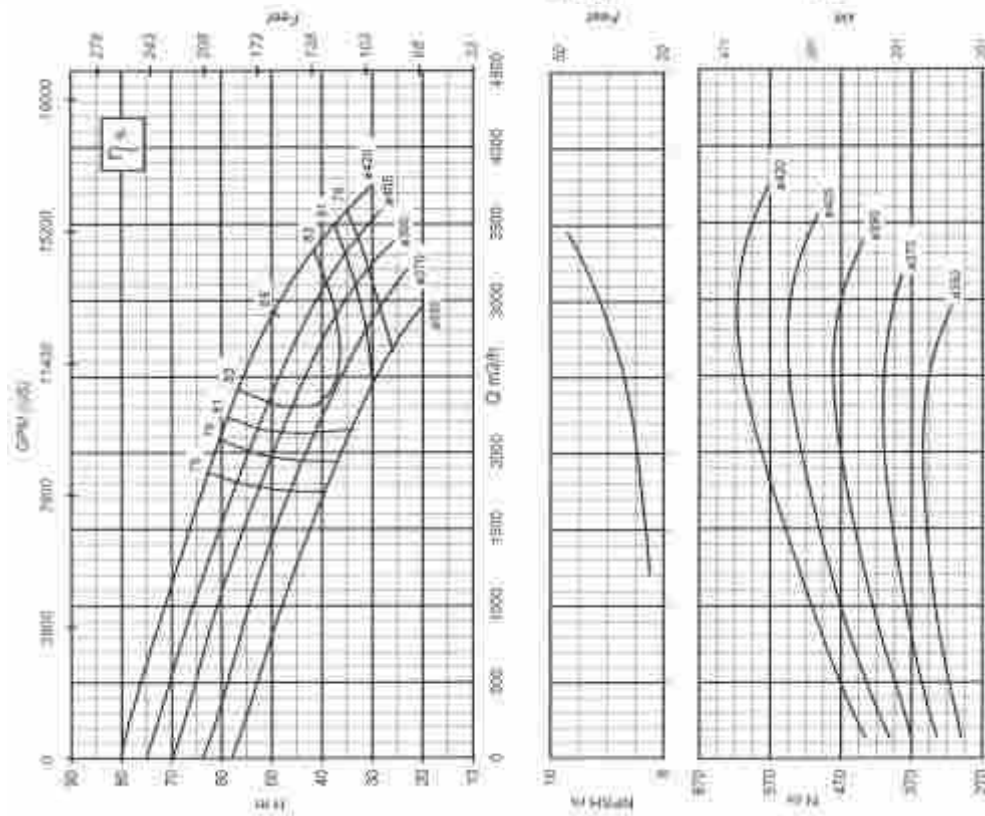

Impeller Ø Max.	420 mm	Suction Flange	500 mm
Impeller Ø Min.	350 mm	Pressure Flange	400 mm
Viscosity	$\mu = 1 \text{ cP}$	Specific Weight	$\gamma = 1 \text{ kgf/dm}^3$

BP 400-440 ROTOR "B" 1750 RPM

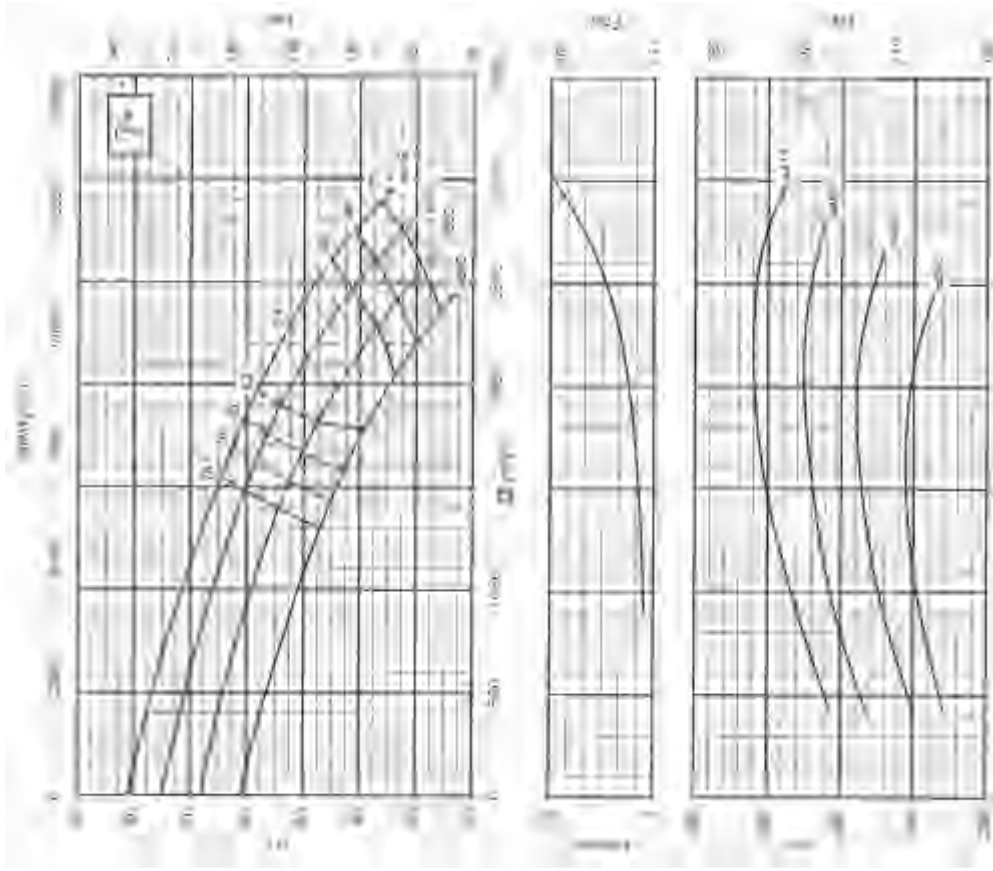

Impeller Ø Max.	415 mm	Suction Flange	500 mm
Impeller Ø Min.	360 mm	Pressure Flange	400 mm
Viscosity	$\mu = 1 \text{ cP}$	Specific Weight	$\gamma = 1 \text{ kgf/dm}^3$

BP 400-440 ROTOR "A" 1750 RPM

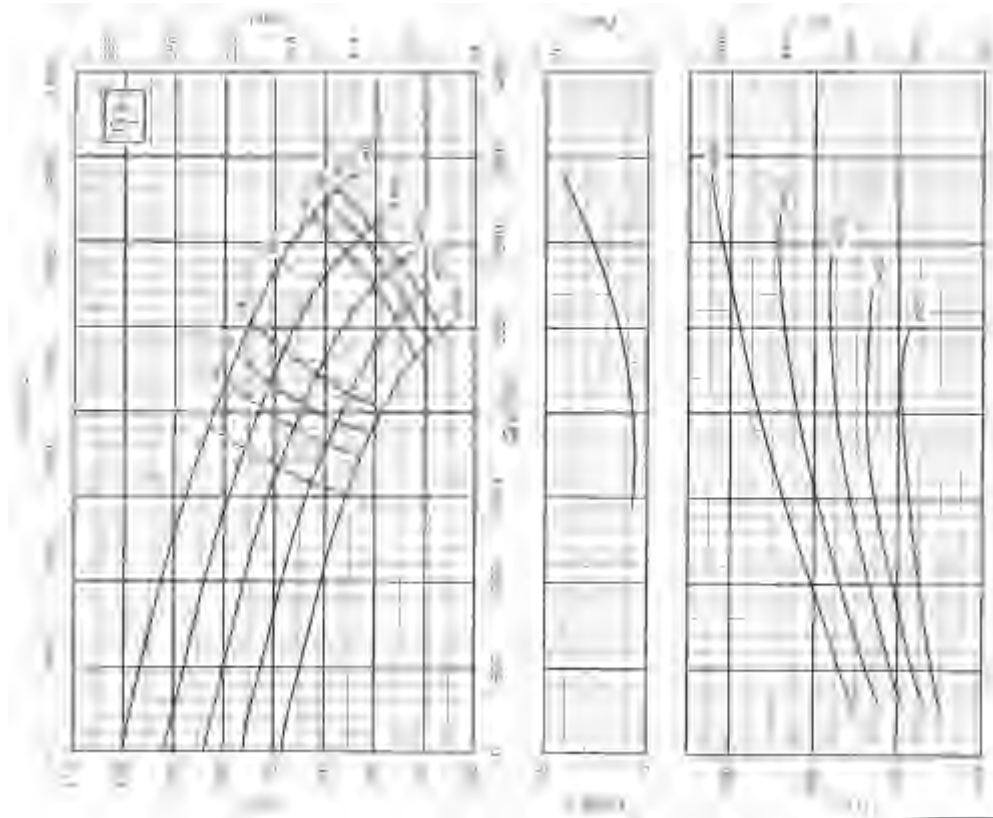

Impeller Ø Max.	460 mm	Suction Flange	500 mm
Impeller Ø Min.	380 mm	Pressure Flange	400 mm
Viscosity	$\mu = 1 \text{ cP}$	Specific Weight	$\gamma = 1 \text{ kgf/dm}^3$

BP 400-900 ROTOR "A" 880 RPM

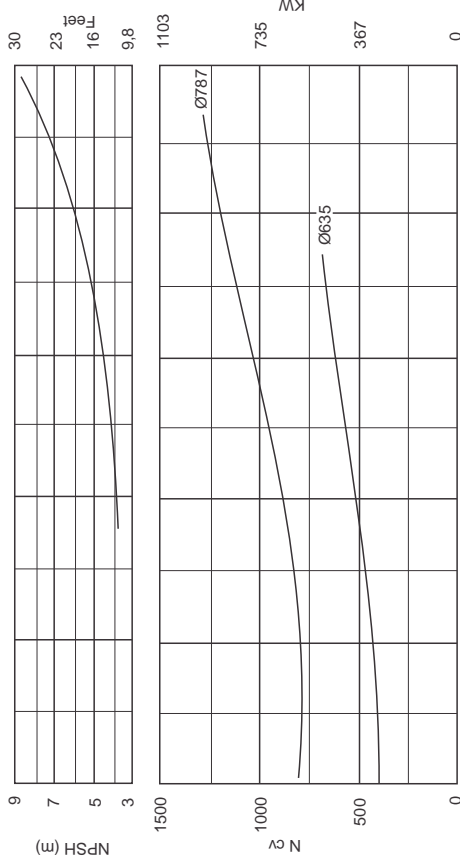
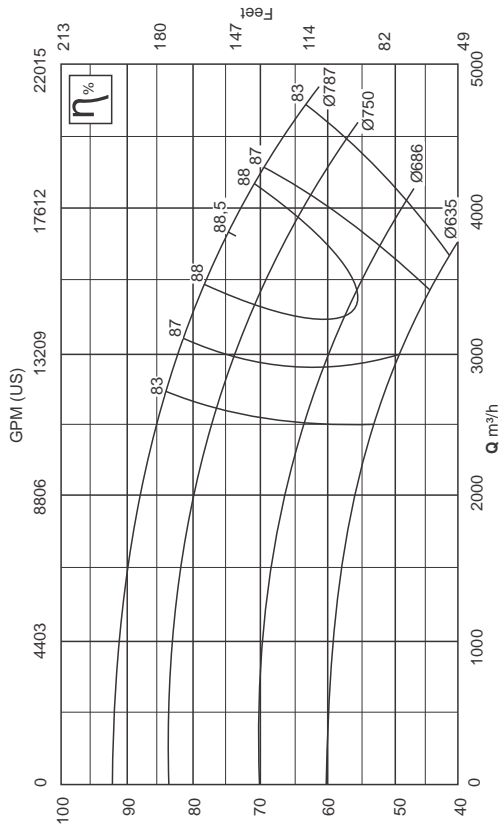

BP 400-900 ROTOR "A" 710 RPM

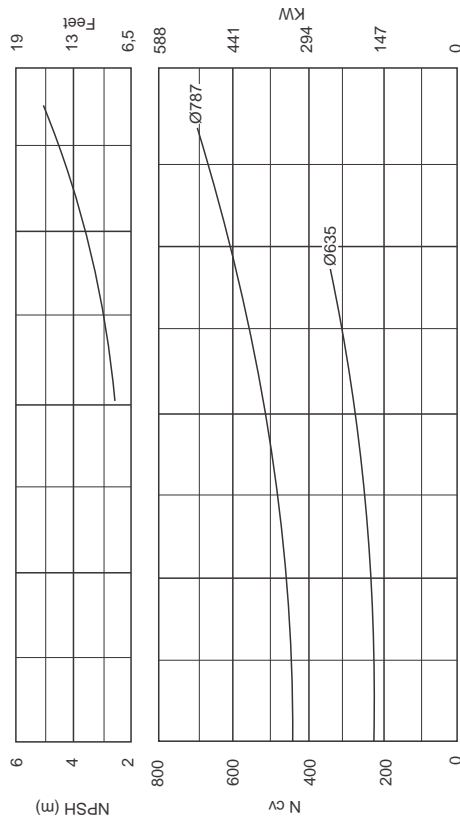
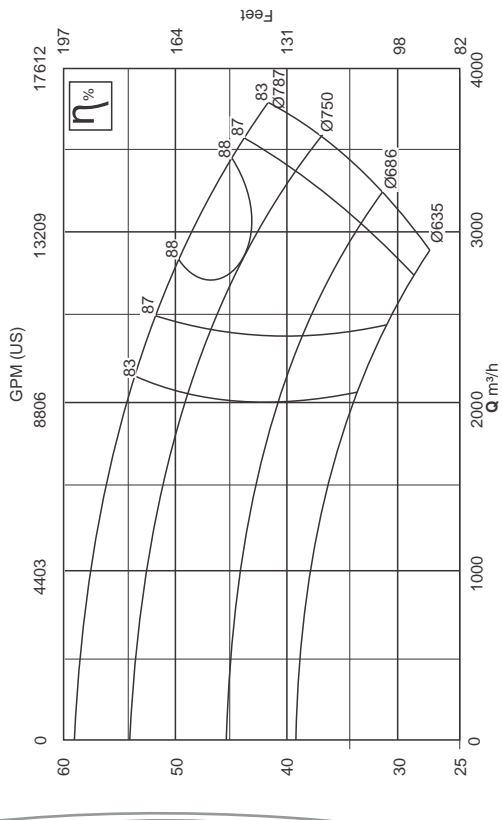

Impeller Ø Max.	787 mm	Suction Flange	600 mm
Impeller Ø Min.	635 mm	Pressure Flange	400 mm
Viscosity	μ = 1 cP	Specific Weight	γ = 1 kgf/dm³

Impeller Ø Max.	787 mm	Suction Flange	600 mm
Impeller Ø Min.	635 mm	Pressure Flange	400 mm
Viscosity	μ = 1 cP	Specific Weight	γ = 1 kgf/dm³

BP 500-510 ROTOR "B" 1160 RPM

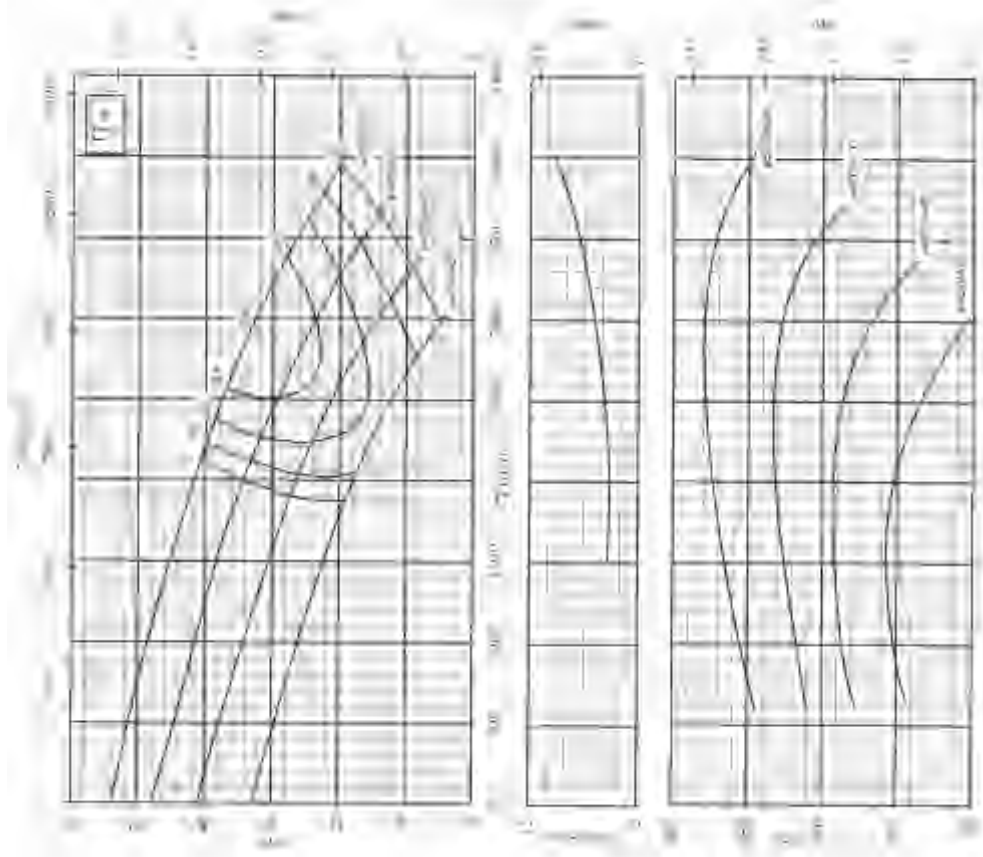

Impeller Ø Max.	505 mm	Suction Flange	600 mm
Impeller Ø Min.	420 mm	Pressure Flange	500 mm
Viscosity	$\mu = 1 \text{ cP}$	Specific Weight	$\gamma = 1 \text{ kgf/dm}^3$

BP 500-510 ROTOR "A" 1160 RPM

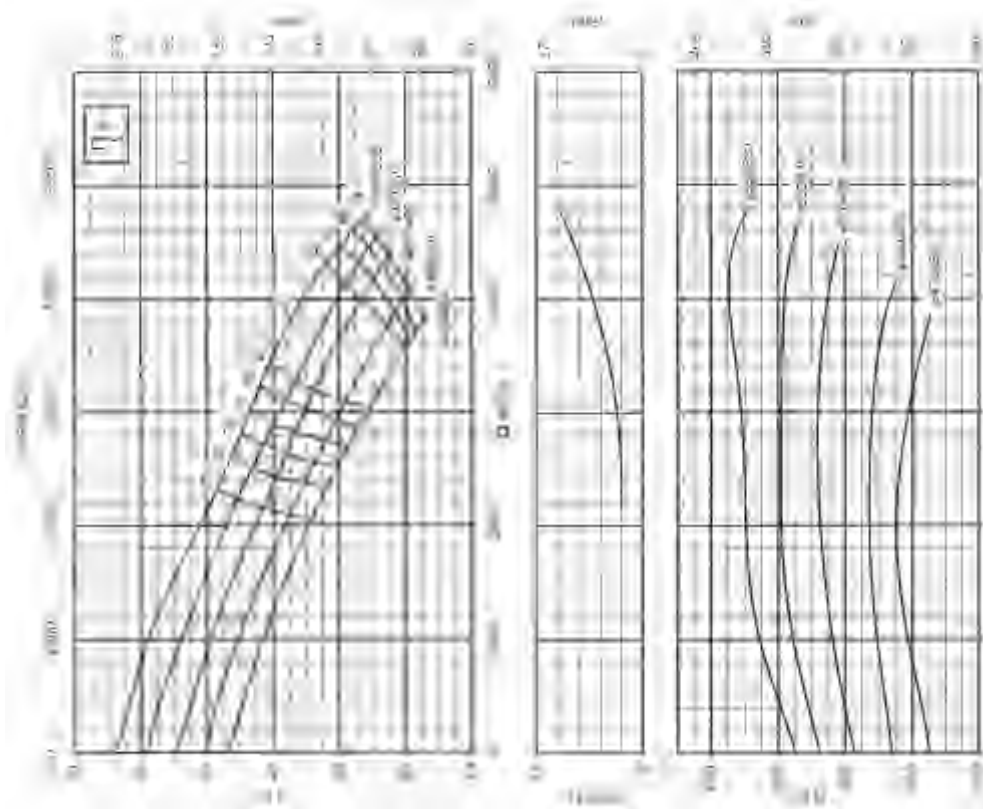

Impeller Ø Max.	550 mm	Suction Flange	600 mm
Impeller Ø Min.	455 mm	Pressure Flange	500 mm
Viscosity	$\mu = 1 \text{ cP}$	Specific Weight	$\gamma = 1 \text{ kgf/dm}^3$

BP 500-640 ROTOR "B" 1160 RPM

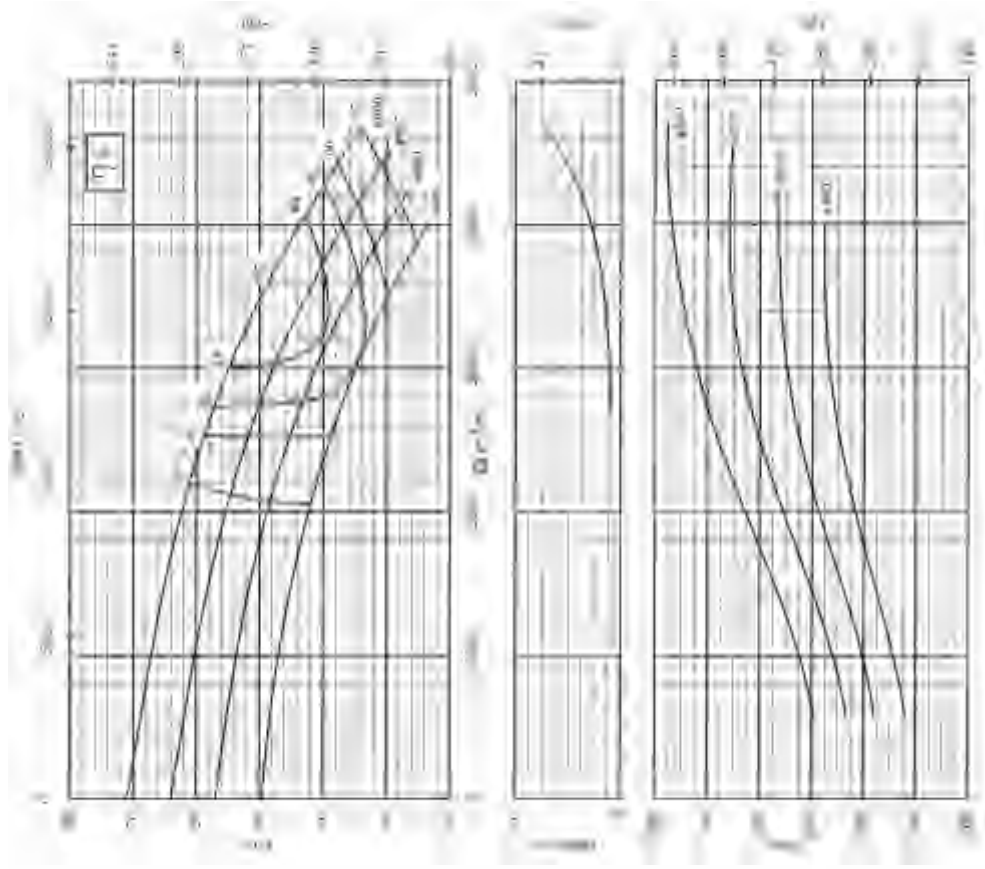

Impeller Ø Max.	580 mm	Suction Flange	600 mm
Impeller Ø Min.	490 mm	Pressure Flange	500 mm
Viscosity	$\mu = 1 \text{ cP}$	Specific Weight	$\gamma = 1 \text{ kgf/dm}^3$

BP 500-640 ROTOR "A" 1160 RPM

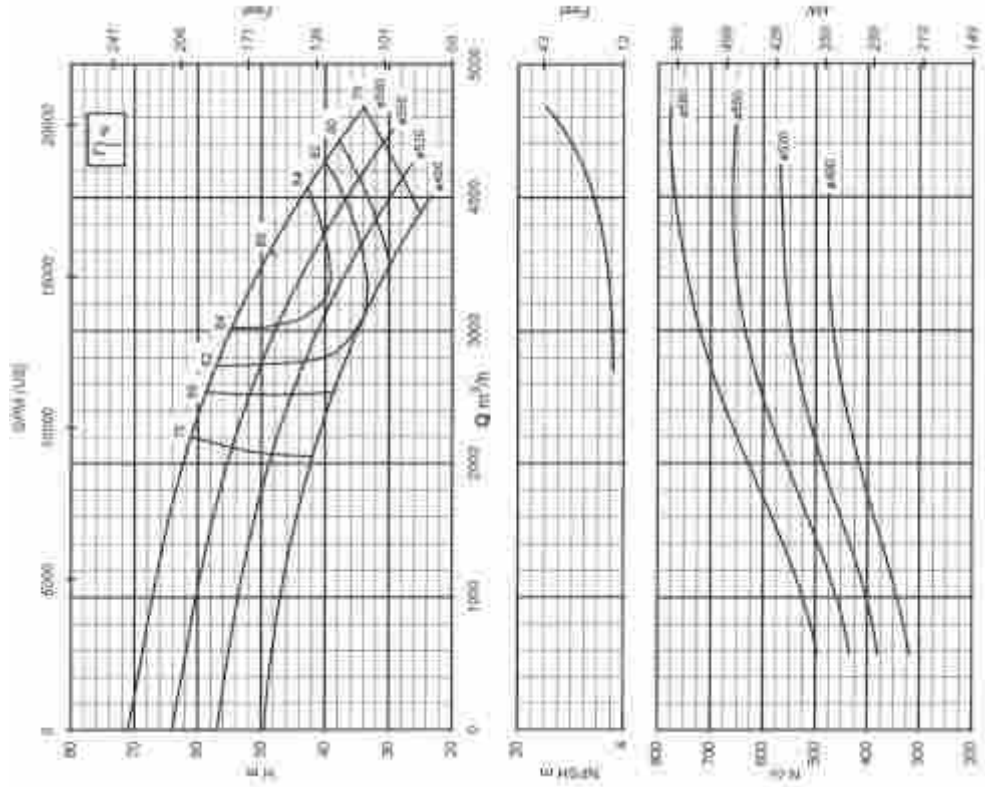

Impeller Ø Max.	580 mm	Suction Flange	600 mm
Impeller Ø Min.	490 mm	Pressure Flange	500 mm
Viscosity	$\mu = 1 \text{ cP}$	Specific Weight	$\gamma = 1 \text{ kgf/dm}^3$

BP 500-700 ROTOR "B" 880 RPM

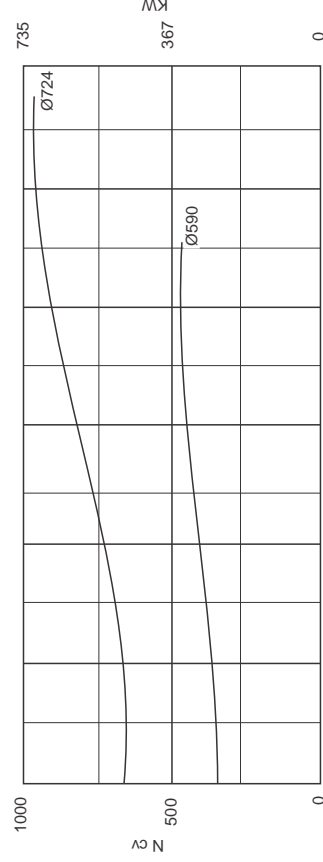
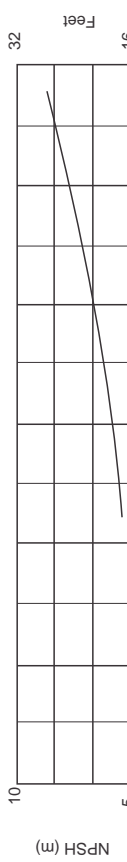
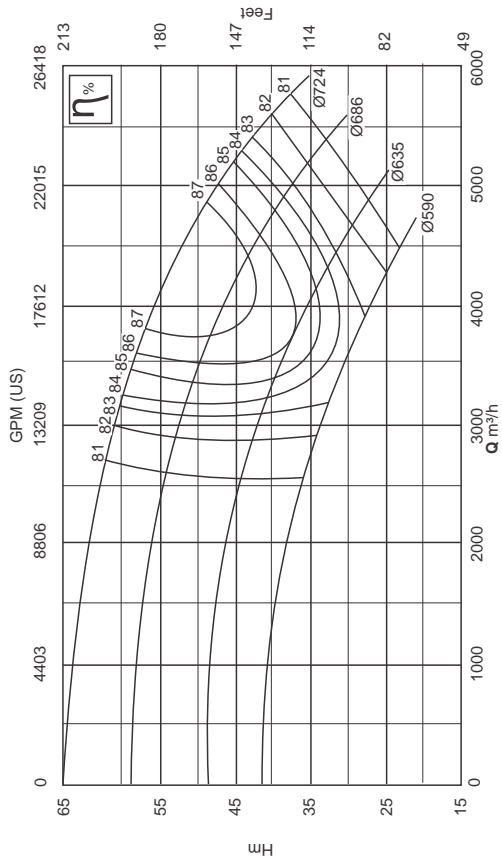

BP 500-700 ROTOR "B" 710 RPM

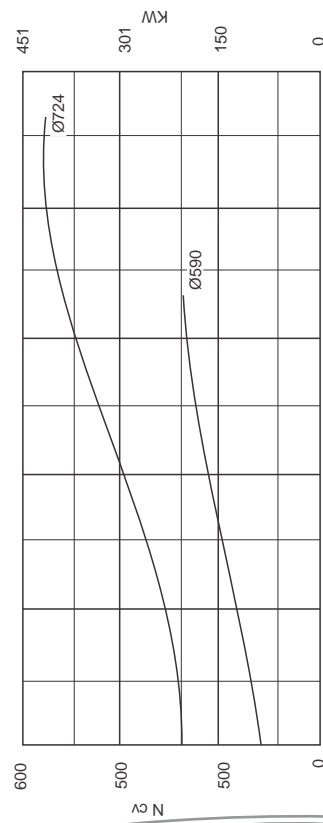
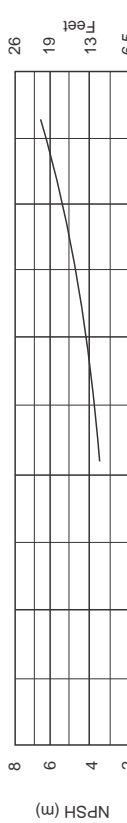
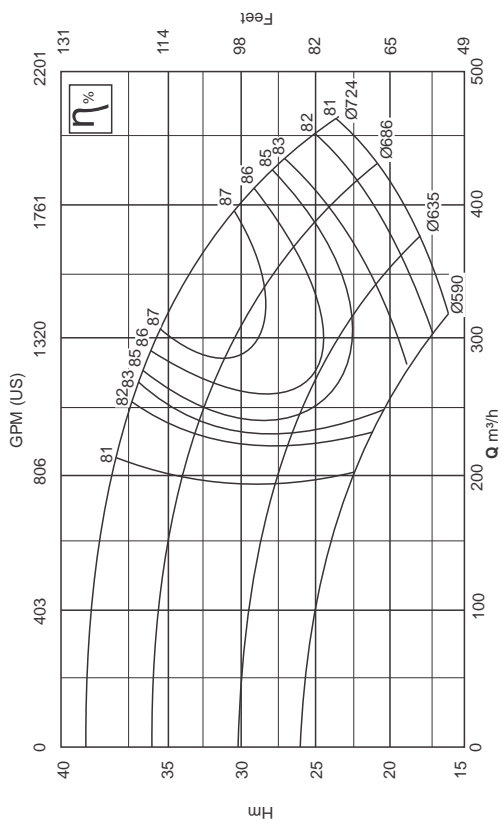

Impeller Ø Max. 724 mm **Suction Flange** 600 mm

Impeller Ø Min. 592 mm **Pressure Flange** 500 mm

Viscosity $\mu = 1 \text{ cP}$ **Specific Weight** $\gamma = 1 \text{ kg/dm}^3$

Impeller Ø Max. 724 mm **Suction Flange** 600 mm

Impeller Ø Min. 594 mm **Pressure Flange** 500 mm

Viscosity $\mu = 1 \text{ cP}$ **Specific Weight** $\gamma = 1 \text{ kg/dm}^3$

BP 600-540 ROTOR "B" 1160 RPM

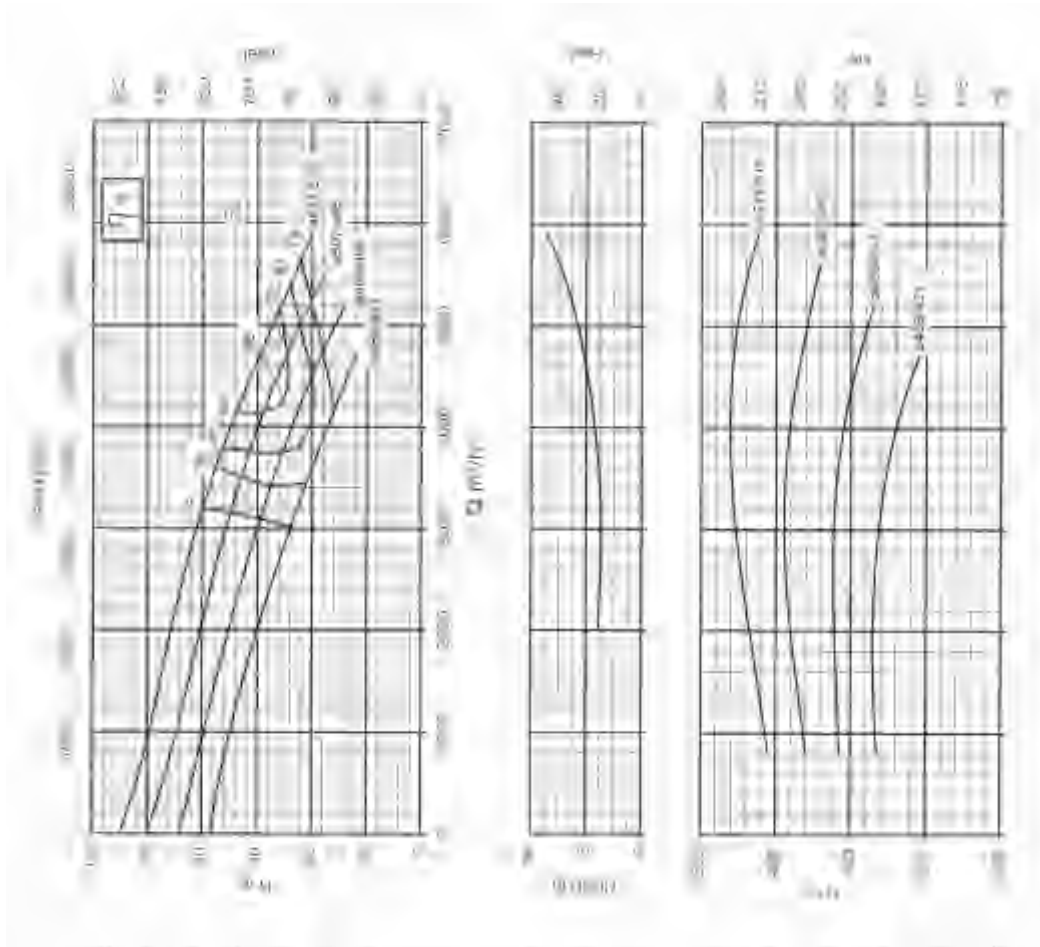

Impeller Ø Max.	531/516 mm	Suction Flange	700 mm
Impeller Ø Min.	459/421 mm	Pressure Flange	600 mm
Viscosity	$\mu = 1 \text{ cP}$	Specific Weight	$\gamma = 1 \text{ kgf/dm}^3$

BP 600-540 ROTOR "A" 1160 RPM

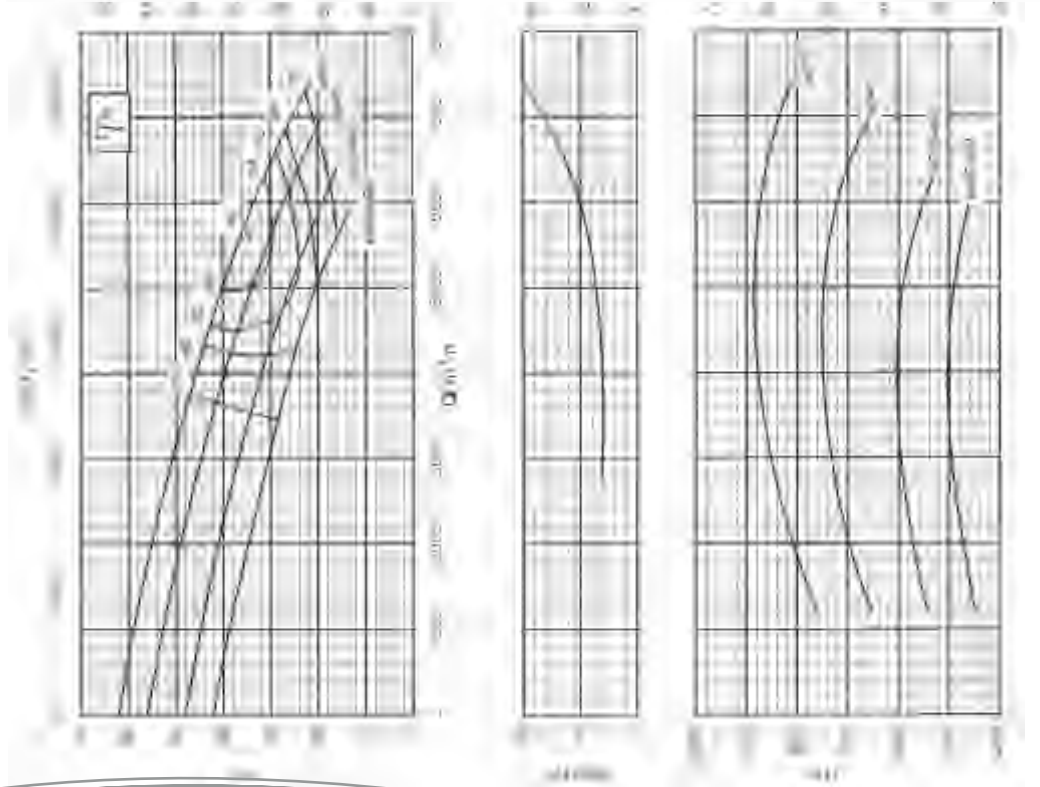

Impeller Ø Max.	570 mm	Suction Flange	700 mm
Impeller Ø Min.	460 mm	Pressure Flange	600 mm
Viscosity	$\mu = 1 \text{ cP}$	Specific Weight	$\gamma = 1 \text{ kgf/dm}^3$

BP 600-620 ROTOR "A" 850 RPM

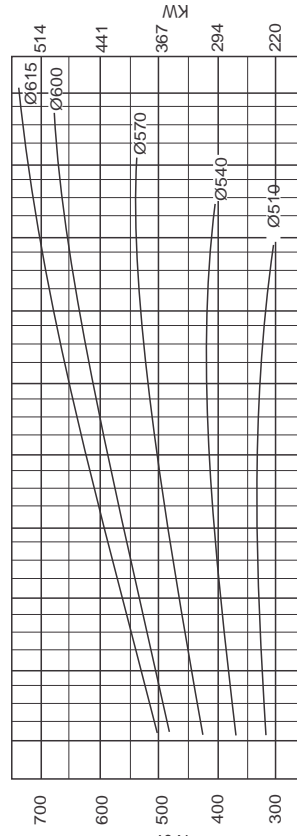
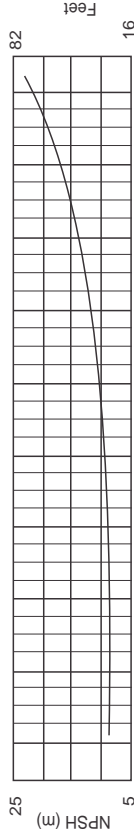
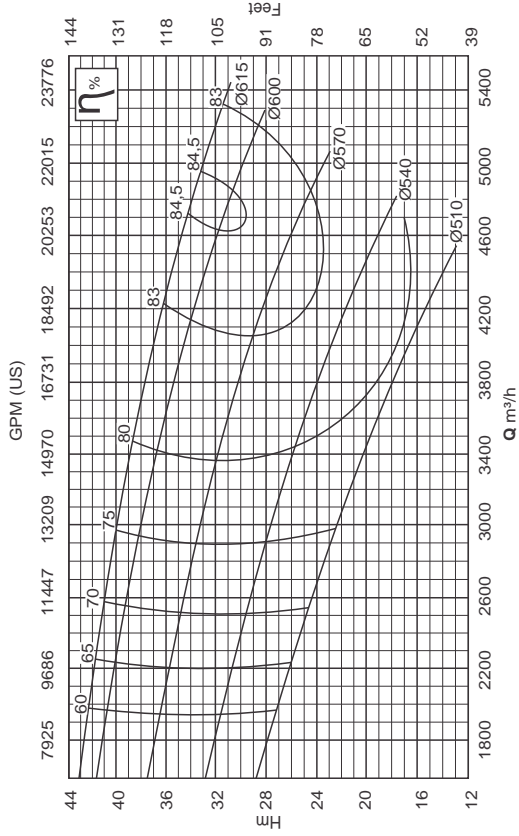

BP 600-620 ROTOR "A" 850 RPM

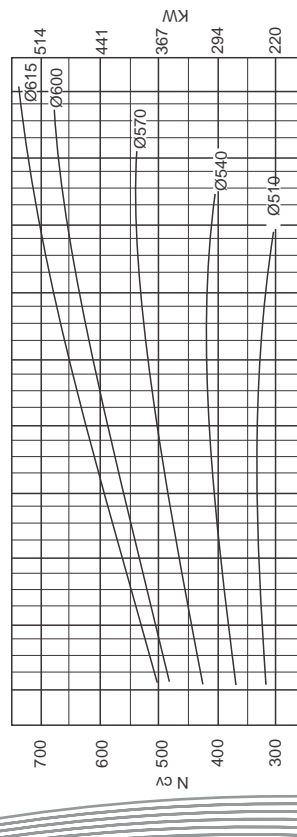
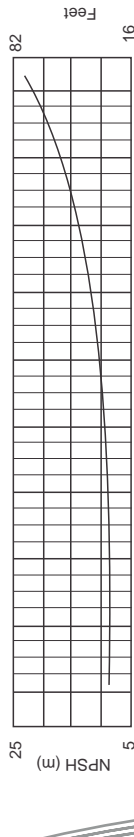
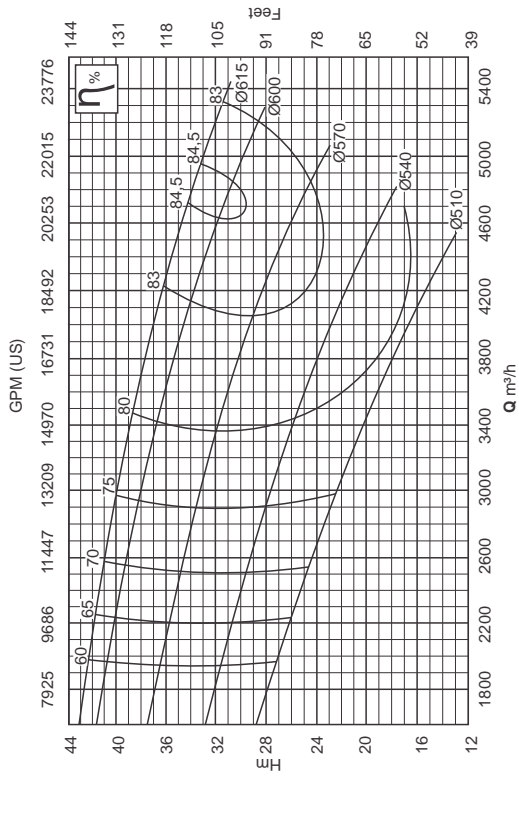

Impeller Ø Max.	615 mm	Suction Flange	830 mm
Impeller Ø Min.	510 mm	Pressure Flange	650 mm
Viscosity	$\mu = 1 \text{ cP}$	Specific Weight	$\gamma = 1 \text{ kgf/dm}^3$

Impeller Ø Max.	615 mm	Suction Flange	830 mm
Impeller Ø Min.	510 mm	Pressure Flange	650 mm
Viscosity	$\mu = 1 \text{ cP}$	Specific Weight	$\gamma = 1 \text{ kgf/dm}^3$

BP 750-1000 ROTOR "E" 585 RPM

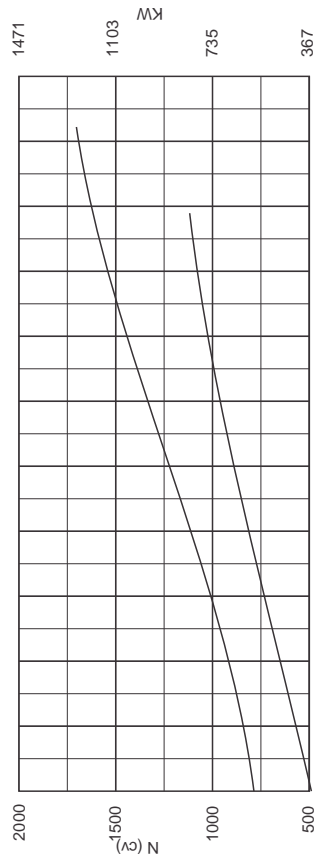
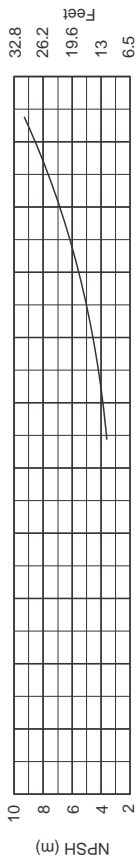
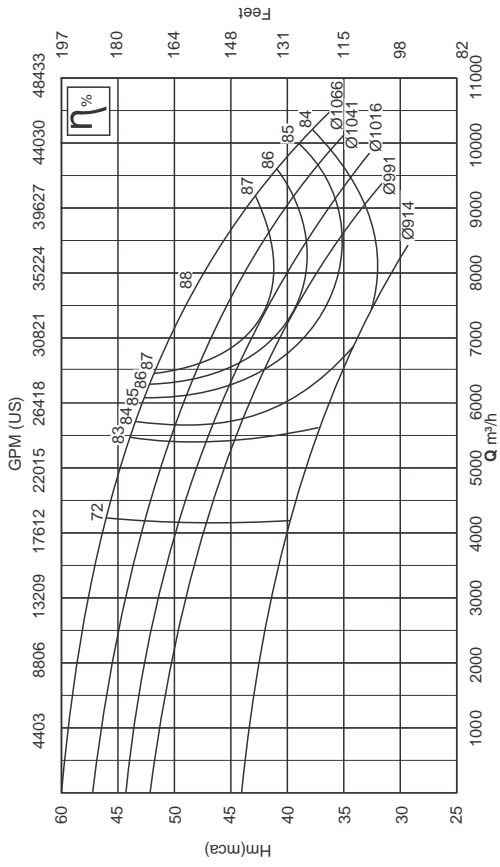

Impeller Ø Max.	1066 mm	Suction Flange	910 mm
Impeller Ø Min.	914 mm	Pressure Flange	760 mm
Viscosity	$\mu = 1 \text{ cP}$	Specific Weight	$\gamma = 1 \text{ kgf/dm}^3$

BP 750-1000 ROTOR "E" 505 RPM

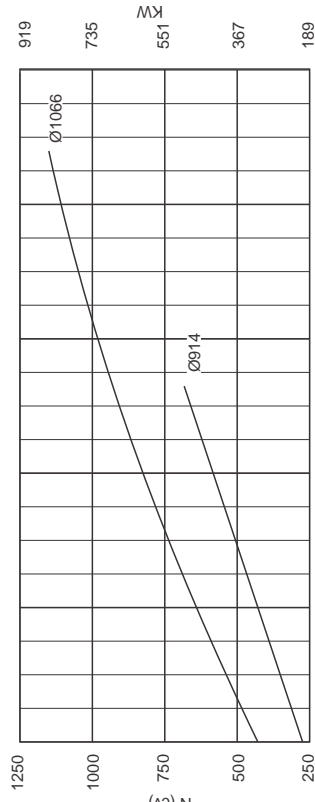
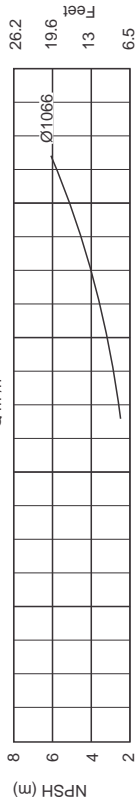
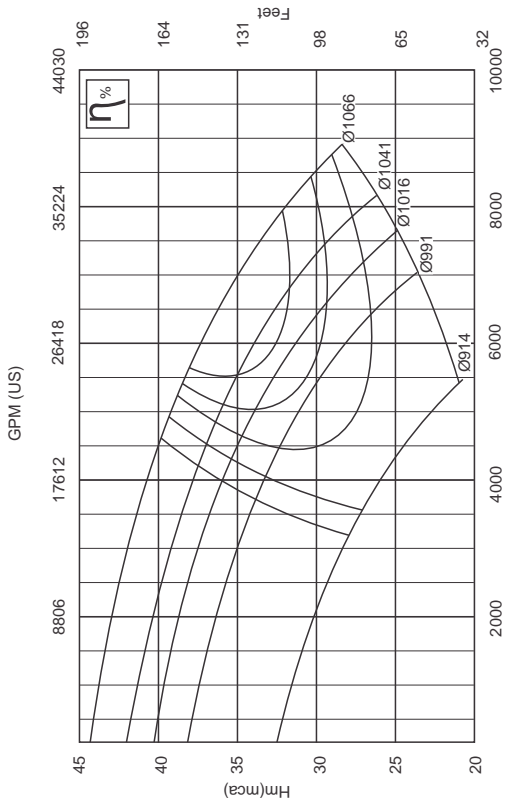

Impeller Ø Max.	1066 mm	Suction Flange	910 mm
Impeller Ø Min.	914 mm	Pressure Flange	760 mm
Viscosity	$\mu = 1 \text{ cP}$	Specific Weight	$\gamma = 1 \text{ kgf/dm}^3$

BP 750-1000 ROTOR "B" 585 RPM

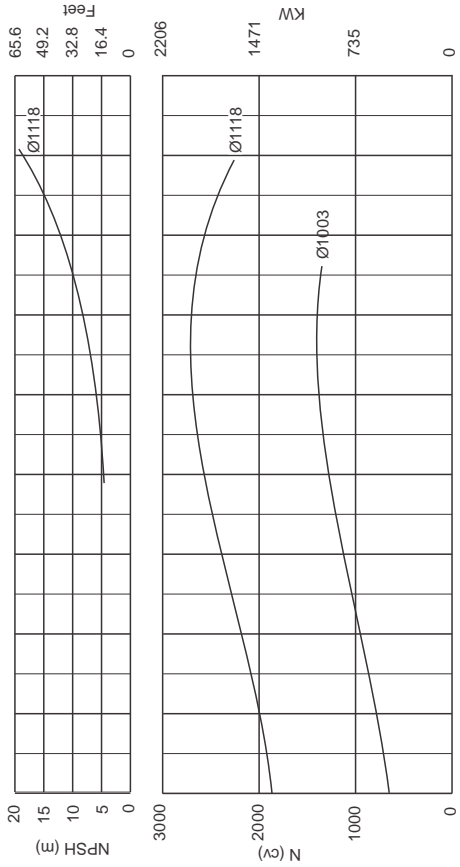
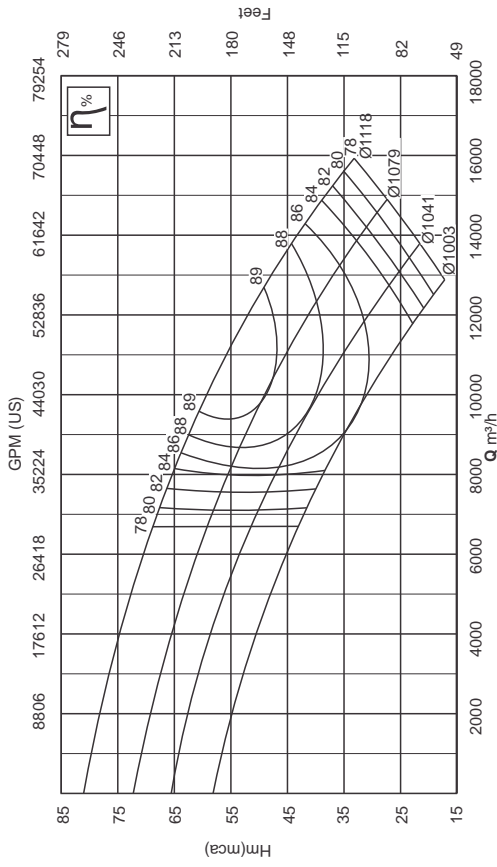

Impeller Ø Max.	1118 mm	Suction Flange	910 mm
Impeller Ø Min.	1003 mm	Pressure Flange	760 mm
Viscosity	$\mu = 1 \text{ cP}$	Specific Weight	$\gamma = 1 \text{ kgf/dm}^3$

BP 750-1000 ROTOR "B" 505 RPM

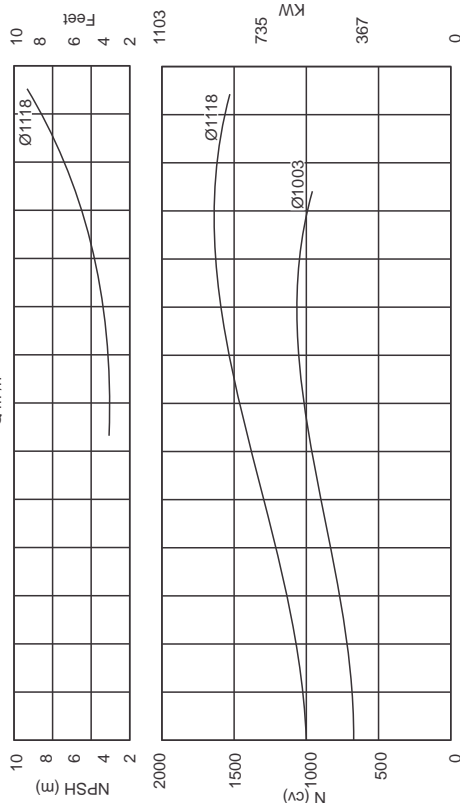
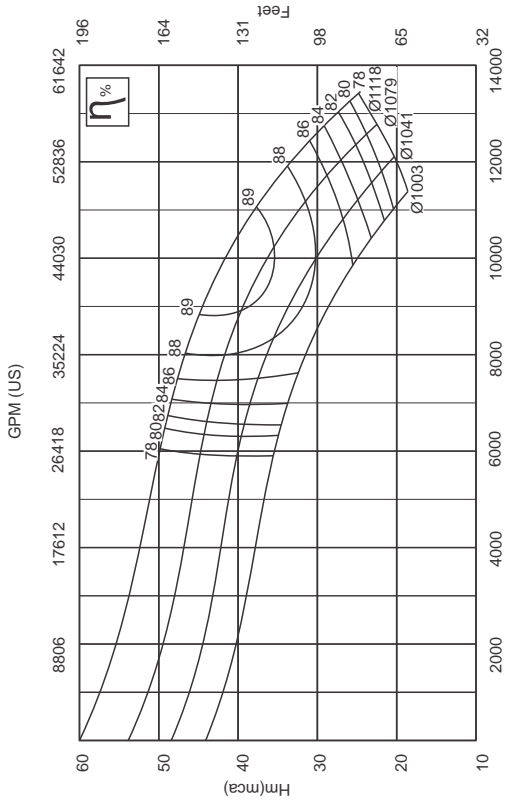

Impeller Ø Max.	1118 mm	Suction Flange	910 mm
Impeller Ø Min.	1003 mm	Pressure Flange	760 mm
Viscosity	$\mu = 1 \text{ cP}$	Specific Weight	$\gamma = 1 \text{ kgf/dm}^3$