

# Submersible Wastewater Pump Type ABS AS 0530 - 0841

**SULZER**



Robust, reliable submersible pumps from 1 to 3 kW for pumping clear water, wastewater and sewage from buildings and sites in domestic and commercial areas.

## Applications

AS submersible pumps have been designed for the economic and reliable pumping of wastewater and sewage, and can be used with automatic coupling system for fixed applications or as portable units.

- The 2" discharge version is especially suitable for pumping wastewater from underground garages.
- With vortex hydraulics the AS is particularly suitable for fluids containing fibrous or abrasive matter and for sewage.
- The Contrablock hydraulic system is suitable for larger proportions of solid or fibrous matter.
- Maximum allowable temperature of the medium is 40 °C, or short term to 60 °C (max. 5 minutes).

## Construction

The water-pressure-tight, encapsulated fully flood-proof motor and the pump section form a compact, robust, unit construction.

## Motor

Single-phase 220-240 V and three-phase 400 V, 50 Hz, 2-pole (2900 r/min) and 4-pole (1450 r/min). Insulation class F; protection type IP68. Ex protection to ATEX II 2G Ex h db IIB T4 Gb and FM international standards.

Consult Sulzer for Ex usage with frequency inverters.

**Types of operation and frequency of starting:** Pumps of the AS series have been designed for intermittent use only (S3, 25%) when dry-installed, and continuous use (S1) when submerged.

## Bearings

The stainless steel motor shaft is supported in lubricated-for-life ball bearings.

## Shaft sealing

Between motor and hydraulic section by means of a high quality sealing unit using a silicon carbide mechanical seal, independent of direction of rotation and resistant to temperature shock. Seal at motor side is by oil lubricated lip seal.

## Discharge

**AS 0530:** G 2" internal thread (DN 50).

**AS 0630 to 0641:** radial slot DN 65 flange.

**AS 0830, 0831, 0840 & 0841:** radial slot DN 80 flange.

## Temperature monitoring

Thermal sensors in the stator to switch off the pump in the case of overheating and switch on automatically after cooling down (option on standard AS). Temperature and leakage relays are required (see accessories table).

## Seal monitoring

DI system consisting of a sensor in the motor and seal chambers which signals an inspection alert if there is leakage at the shaft seals (not in seal chamber on Ex version). Temperature and leakage relays are required (see accessories table).



## Hydraulics

AS 0530, 0630, 0631, 0830, 0831: vortex, open, recessed four-vane impeller.

AS 0641, 0840, 0841: Contrablock, open single-vane impeller with spiral bottom plate.

## Identification Code

e.g. AS 0840 S 12/2 Ex

Hydraulics:

AS ..... Product range

08 ..... Discharge outlet DN (cm)

40 . .....Hydraulic type

Motor:

S ..... Modular motor version

12 ..... Motor power  $P_2$  kW x 10

2 ..... Number of poles

Ex ..... Explosive-proof

## Features

- Hydraulic design with Contrablock system or vortex impellers.
- High reliability even under long term operating conditions.
- For wastewater and sewage containing solid or fibrous particles.
- In standard or Ex-versions.
- Option of automatic seal and temperature monitoring. Ex version has temperature monitoring as standard.
- Available for transportable or fixed installation.

## Materials

Description	Material
Motor housing	Cast iron EN-GJL-250
Rotor shaft	Stainless steel 1.4021 (AISI 420)
Volute	Cast iron EN-GJL-250
Impeller	Cast iron EN-GJL-250
Bottom plate	Cast iron EN-GJL-250
Fasteners	Stainless steel 1.4401 (AISI 316)

## Technical data

AS	Motor	Solids size (mm)	Discharge *	Rated voltage (V)	Motor power ** (kW)		Rated current (A)	Speed (r/min)	Weight *** (kg)
					P <sub>1</sub>	P <sub>2</sub>			
0530	S12/2W <sup>(†)</sup>	40	G 2"	220-240 1~	1.77	1.20	8.22	2900	34
	S12/2D	40	G 2"	400 3~	1.69	1.20	3.29	2900	34
	S17/2D	40	G 2"	400 3~	2.31	1.70	3.97	2900	34
	S26/2D	40	G 2"	400 3~	3.43	2.60	5.64	2900	40
0630	S10/4W <sup>(†)</sup>	60	DN 65	220-240 1~	1.69	1.00	7.49	1450	37
	S13/4D	60	DN 65	400 3~	1.93	1.30	3.60	1450	37
	S22/4D	60	DN 65	400 3~	2.88	2.20	5.15	1450	42
0631	S12/2W <sup>(†)</sup>	40	DN 65	220-240 1~	1.77	1.20	8.22	2900	38
	S12/2D	40	DN 65	400 3~	1.69	1.20	3.29	2900	38
	S17/2W <sup>(†)</sup>	40	DN 65	220-240 1~	2.36	1.65	10.60	2900	38
	S17/2D	40	DN 65	400 3~	2.31	1.70	3.97	2900	38
	S30/2D	40	DN 65	400 3~	3.74	3.00	6.23	2900	46
0641	S30/2D	45	DN 65	400 3~	3.74	3.00	6.23	2900	42
0830	S10/4W <sup>(†)</sup>	60	DN 80	220-240 1~	1.69	1.00	7.49	1450	40
	S13/4D	60	DN 80	400 3~	1.93	1.30	3.60	1450	40
	S22/4D	60	DN 80	400 3~	2.88	2.20	5.15	1450	42
0831	S22/4D	80	DN 80	400 3~	2.88	2.20	5.15	1450	55
0840	S12/2W <sup>(†)</sup>	30	DN 80	220-240 1~	1.77	1.20	8.22	2900	35
	S12/2D	30	DN 80	400 3~	1.69	1.20	3.29	2900	35
	S17/2D	30	DN 80	400 3~	2.31	1.70	3.97	2900	35
	S26/2D	30	DN 80	400 3~	3.43	2.60	5.64	2900	40
0841	S13/4D	80	DN 80	400 3~	1.93	1.30	3.60	1450	49
	S22/4D	80	DN 80	400 3~	2.88	2.20	5.15	1450	58

\* G = internal thread, DN = flange

\*\* P<sub>1</sub> = Power at mains; P<sub>2</sub> = Power at motor shaft.

\*\*\* Weight with 10 m cable. Cable size: Standard = 4G1.5, Ex = 7G1.5

<sup>(†)</sup> Start and Run capacitor to the following specification required in control panel.

Start: 125-160µF. Run: 40µF (2x20µF) for S10/4W, 30µF for S12/2W & S17/2W.

The recommended start time for the motors is two seconds.

## Dimensions (mm)

AS		A	B	C	D	E	F	G	H	J	K	L	M	N	O	P
0530	S12/2 & 17/2	432	293	331	160	236	125	175	133	100	18	155	n.a.	20	n.a.	n.a.
	S26/2	444	293	331	160	236	125	175	133	100	18	155	n.a.	20	n.a.	n.a.
0630	S10/4 & 13/4	437	309	348	157	294	140	247	147	57	18	245	195	15	132	40
	S22/4	450	309	348	157	294	140	247	147	57	18	245	195	15	132	40
0631	S12/2 & 17/2	409	305	346	160	237	140	247	145	54	18	245	195	15	132	40
	S30/2	421	305	346	160	237	140	247	145	54	18	245	195	15	132	40
0641	S30/2	428	308	346	160	237	140	247	148	54	18	245	195	15	132	40
0830	S10/4 & 13/4	437	307	408	160	294	200	342	147	88	18	275	195	20	182	25
	S22/4	450	307	408	160	294	200	342	147	88	18	275	195	20	182	25
0831	S22/4	470	397	445	240	312	200	340	157	88	18	275	195	20	182	25
0840	S12/2 & 17/2	418	280	379	130	210	200	342	148	88	18	275	195	20	182	25
	S26/2	430	280	379	130	210	200	342	148	88	18	275	195	20	182	25
0841	S13/4	473	397	445	240	312	200	340	157	88	18	275	195	20	182	25
	S22/4	485	397	450	240	312	200	340	157	88	18	275	195	20	182	25

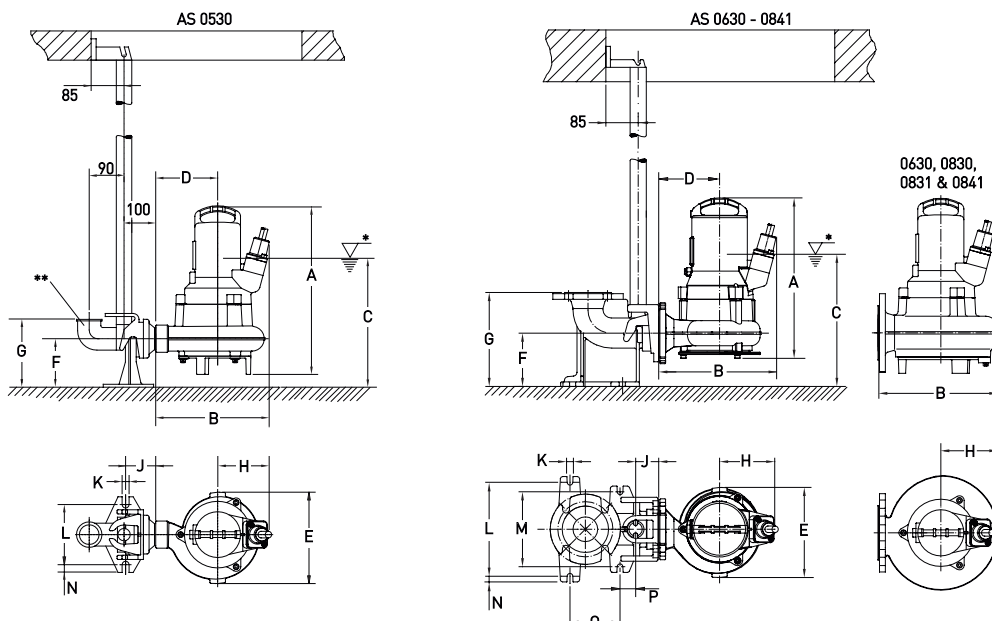

\* Lowest switch-off level; minimum switch-on level must be at least 100 mm higher.

\*\* Elbow not supplied.

# Performance Curves

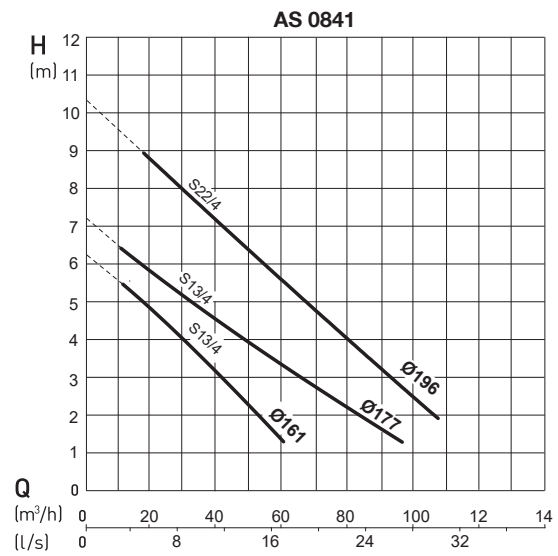
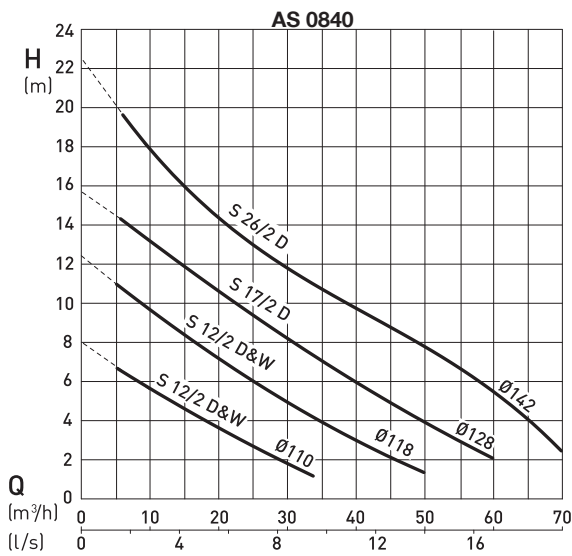
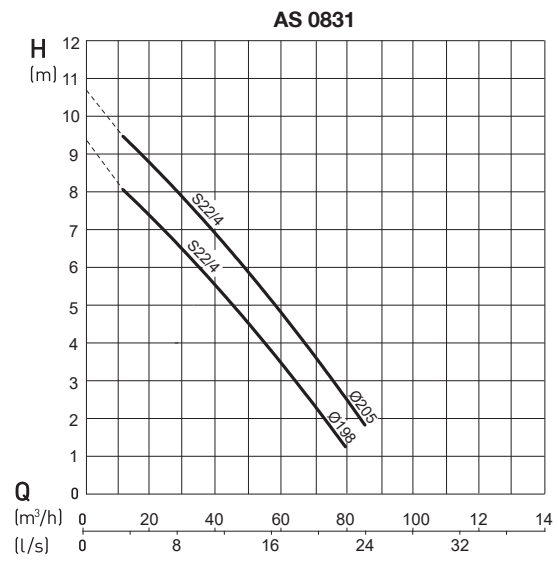
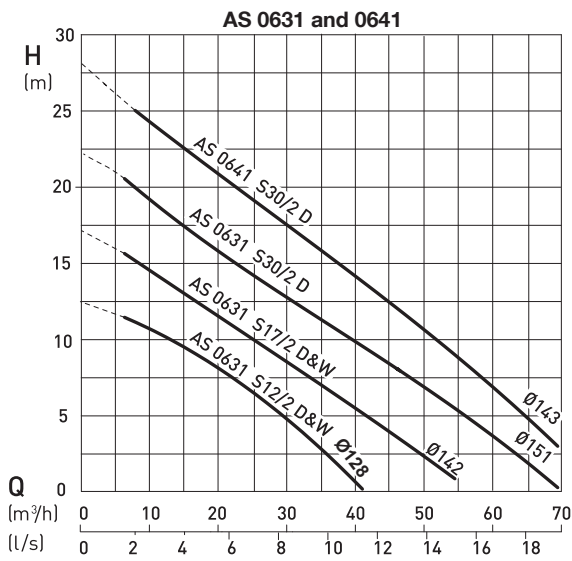
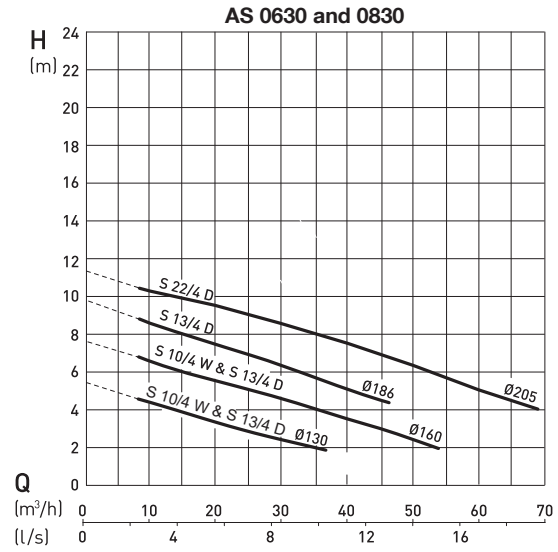
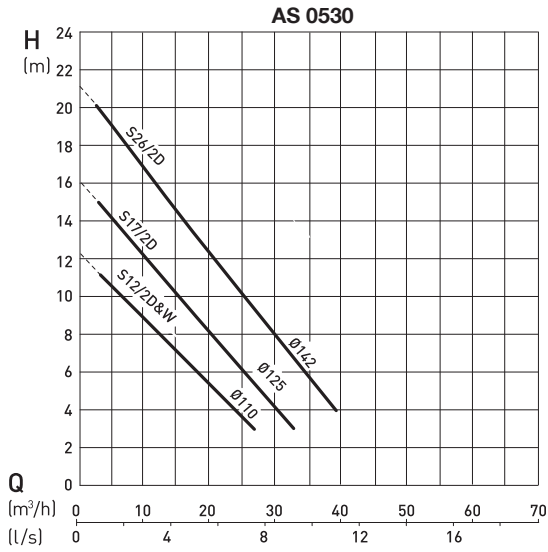

H = Total Head; Q = Discharge Volume. Curves to ISO 9906 (60 Hz available on request). N.B. please use the ABSEL program to validate pump selection.

## Accessories

	Description	Size	Part no.	AS	
Fixed installation with Sulzer Automatic Coupling System	<b>Pedestal</b> (cast iron EN-GJL-250) threaded (with fixing bolts and transition piece) flange (with fixing bolts) flange (with fixing bolts) flange (fixing bolts not included) flange (with plug/clamp connection and fixing bolts)	2" without bend	62320560	0530	
		DN 65: 90° cast bend	62320673	0630 - 0641	
		DN 80 without bend	62320557	0830/31/40/41	
		DN 80: 90° cast bend	62320649	0830/31/40/41	
		DN 80: 90° cast bend	62320650	0830/31/40/41	
	<b>Fasteners</b> (galvanized steel) bolts and gasket (bracket to pump) anchor bolts (pedestal to base)			62610632	0830/31/40/41
				62610775	0830/31/40/41
	<b>Guide Rail</b> (galvanized steel)	1¼" x 1 m	31380007	0530 - 0641	
		1¼" x 2 m	31380008		
		1¼" x 3 m	31380009		
1¼" x 4 m		31380010			
1¼" x 5 m		31380011			
<b>Chain Kit</b> (stainless steel)  Working load limit (WLL) 320 kg	1.6 m	310101395001	0530 - 0841		
	3.0 m	310101236003			
	4.0 m	310101236004			
	6.0 m	310101236006			
	7.0 m	310101236007			
Fixed installation - dry well, (horizontal)	<b>Pump Support Kit</b> (EN-GJL-250) head and volute supports with fixing bolts and vibration damper		61825001	0831 & 0841	
			62665103	0630, 0830, 0840	
Transportable installation	<b>Skirtbase</b>		61355013	0630 & 0830	
			61355012	0631 & 0641	
			61350526	0831 & 0841	
	<b>Discharge Elbow</b> (EN-GJL-250) flange to thread flange to STORZ coupling	DN 80 to G 2½"	31090131	0840	
DN 80 to G 2½"		62665074			
General	<b>Adaptor</b> (galvanized steel)	DN 65 to DN 80	21405002	0630, 0631 & 0641	
General	<b>Non-return Ball Valve</b> (EN-GJL-250) internal thread internal thread with inspection hatch flange with inspection hatch and venting flange with inspection hatch	G 2"	61400527	0530	
		G 2½"	61400543	0630 - 0641	
		DN 80	61400534	0830/31/40/41	
		DN 80	61400523	0830/31/40/41	
	<b>Gate Valve</b> (brass) (EN-GJL-250)	G 2"	14040007	0530	
		DN 80	61420500	0830, 0831, 0840 & 0841	
	<b>Leakage Relay Type ABS CA 461</b>	110 - 230 VAC	16907010	0530 - 0841	
		18 - 36 VDC, SELV	16907011	0530 - 0841	
	<b>Temperature and Leakage Relay Type ABS CA 462</b>	110 - 230 VAC	16907006	0530 - 0841	
18 - 36 VDC, SELV		16907007	0530 - 0841		

## Design

1. Ball bearings; lubricated-for-life.
2. Watertight cable entry.
3. Motor with thermal sensor in air-filled motor housing.
4. Seal chamber with seal monitoring.
5. Sic/Sic mechanical seal.
6. Contrablock (featured) or vortex hydraulics.

